



RADIO TESTREPORT

Report No:STS2205025W02

Issued for

WIZnet H.K. LTD.

Unit 219, Building 1W, Hong Kong Science Park, Pak Shek
Kok, New Territories, Hong Kong

Product Name:	WiFi Module
Brand Name:	WIZnet
Model Name:	WizFi360
Series Model:	WizFi360-PA,WizFi360-CON
FCC ID:	2ATUB-WIZFI360PA
Test Standard:	FCC Part 15.247

Any reproduction of this document must be done in full. No single part of this document may be reproduced without permission from STS, All Test Data Presented in this report is only applicable to presented Test sample.





TEST RESULT CERTIFICATION

Applicant's Name: WIZnet H.K. LTD.
 Address: Unit 219, Building 1W, Hong Kong Science Park, Pak Shek Kok, New Territories, Hong Kong
Manufacture's Name: WIZnet Co., Ltd.
 Address: 5F Humax Village,216 Hwangsaedul-ro, Bundang-gu, Seongnam-si, Gyeonggi-do, 13595 Korea

Product Description

Product Name.....: WiFi Module
 Brand Name.....: WIZnet
 Model Name: WizFi360
 SeriesModel.....: WizFi360-PA,WizFi360-CON

Test Standards: FCC Part15.247

Test Procedure.....: ANSI C63.10-2013

This device described above has been tested by STS, the test results show that the equipment under test (EUT) is in compliance with the FCC requirements. And it is applicable only to the tested sample identified in the report.

This report shall not be reproduced except in full, without the written approval of STS, this document only be altered or revised by STS, personal only, and shall be noted in the revision of the document.

Date of Test

Date (s) of performance of tests: 10 June 2019 ~ 02 Aug. 2019

Date of Issue: 10 May 2022

Test Result.....: **Pass**

Testing Engineer : 

 (Chris Chen)

Technical Manager : 

 (Sunday Hu)

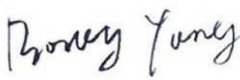
Authorized Signatory : 

 (Bovey Yang)

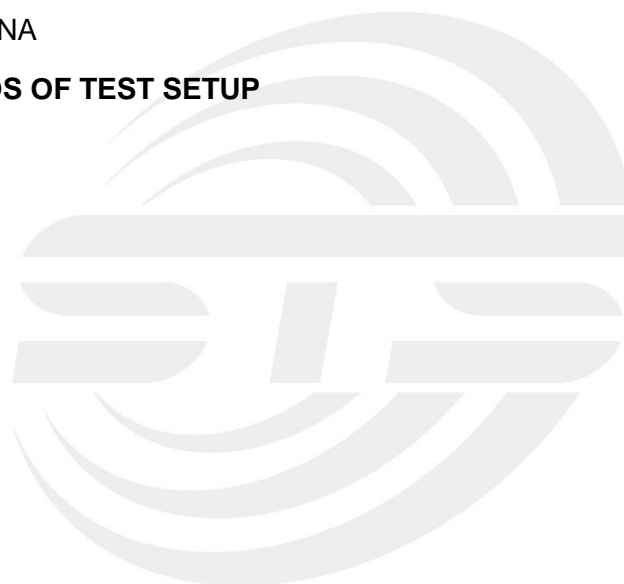



Table of Contents	Page
1. SUMMARY OF TEST RESULTS	6
1.1 TEST FACTORY	7
1.2 MEASUREMENT UNCERTAINTY	7
2. GENERAL INFORMATION	8
2.1 GENERAL DESCRIPTION OF THE EUT	8
2.2 DESCRIPTION OF THE TEST MODES	10
2.3 BLOCK DIGRAM SHOWING THE CONFIGURATION OF SYSTEM TESTED	11
2.4 DESCRIPTION OF NECESSARY ACCESSORIES AND SUPPORT UNITS	11
2.5 EQUIPMENTS LIST FOR ALL TEST ITEMS	12
3. EMC EMISSION TEST	13
3.1 CONDUCTED EMISSION MEASUREMENT	13
3.2 RADIATED EMISSION MEASUREMENT	15
4.CONDUCTED SPURIOUS & BAND EDGE EMISSION	32
4.1 LIMIT	32
4.2 TEST PROCEDURE	32
4.3DEVIATION FROM STANDARD	32
4.4 TEST SETUP	32
4.5 EUT OPERATION CONDITIONS	32
4.6 TEST RESULTS	33
5. POWER SPECTRAL DENSITY TEST	57
5.1 LIMIT	57
5.2 TEST PROCEDURE	57
5.3 DEVIATION FROM STANDARD	57
5.4 TEST SETUP	57
5.5 EUT OPERATION CONDITIONS	57
5.6 TEST RESULTS	58
6. BANDWIDTH TEST	74
6.1 LIMIT	74
6.2 TEST PROCEDURE	74
6.3 DEVIATION FROM STANDARD	74
6.4 TEST SETUP	74
6.5 EUT OPERATION CONDITIONS	74
6.6 TEST RESULTS	75



Table of Contents	Page
7. PEAK OUTPUT POWER TEST	91
7.1 LIMIT	91
7.2 TEST PROCEDURE	91
7.3 DEVIATION FROM STANDARD	91
7.4 TEST SETUP	91
7.5 EUT OPERATION CONDITIONS	91
7.6 TEST RESULTS	92
8. ANTENNA REQUIREMENT	94
8.1 STANDARD REQUIREMENT	94
8.2 EUT ANTENNA	94
APPENDIX-PHOTOS OF TEST SETUP	95



**Revision History**

Rev.	Issue Date	Report No.	Effect Page	Contents
00	02 Aug. 2019	STS1906023W02	ALL	Initial Issue
00	10 May 2022	STS2205025W02	ALL	Updated Applicant's Address, Manufacturer's Name/Address and add Model Name.





1. SUMMARY OF TEST RESULTS

Test procedures according to the technical standards:
KDB 558074 D01 15.247 Meas Guidance v05r02

FCC Part 15.247,Subpart C			
Standard Section	Test Item	Judgment	Remark
15.207	Conducted Emission	N/A	--
15.247 (a)(2)	6dB Bandwidth	PASS	--
15.247 (b)(3)	Output Power	PASS	--
15.247 (c)	Radiated Spurious Emission	PASS	--
15.247 (d)	Conducted Spurious & Band Edge Emission	PASS	--
15.247 (e)	Power Spectral Density	PASS	--
15.205	Restricted Band Edge Emission	PASS	--
Part 15.247(d)/part 15.209(a)	Band Edge Emission	PASS	--
15.203	Antenna Requirement	PASS	--

NOTE:

(1) "N/A" denotes test is not applicable in this Test Report

(2) all tests are according to ANSI C63.10-2013 .



1.1 TEST FACTORY

Shenzhen STS Test Services Co., Ltd.

Add. : 1/F., Building B, Zhuoke Science Park, No.190,Chongqing Road,
Fuyong Street, Bao'an District, Shenzhen, Guangdong, China

FCC test Firm Registration Number: 625569

A2LA Certificate No.: 4338.01;

1.2 MEASUREMENT UNCERTAINTY

The reported uncertainty of measurement $y \pm U$, where expanded uncertainty U is based on a standard uncertainty multiplied by a coverage factor of $k=2$, providing a level of confidence of approximately 95 %.

No.	Item	Uncertainty
1	RF output power, conducted	± 0.71 dB
2	Unwanted Emissions, conducted	± 0.63 dB
3	All emissions, radiated 30-200MHz	± 3.43 dB
4	All emissions, radiated 200MHz-1GHz	± 3.57 dB
5	All emissions, radiated >1G	± 4.13 dB
6	Conducted Emission (9KHz-150KHz)	± 3.18 dB
7	Conducted Emission (150KHz-30MHz)	± 2.70 dB



2. GENERAL INFORMATION

2.1 GENERAL DESCRIPTION OF THE EUT

Product Name	WiFi Module														
Trade Name	WIZnet														
Model Name	WizFi360														
Series Model	WizFi360-PA,WizFi360-CON														
Model Difference	1.WizFi360-PA has a PCB antenna onboard, WizFi360-CON doesn't have; 2.WizFi360-CON has an IPEX antenna connector onboard, WizFi360-PA doesn't have; 3.WizFi360-PA has a LED light onboard, WizFi360-CON doesn't have 4.WizFi360 is the same as wizfi360-PA														
Product Description	<p>The EUT is a WizFi360</p> <table border="1"> <tr> <td>Operation Frequency:</td> <td>802.11b/g/n 20: 2412~2462 MHz 802.11n(40MHz):2422~2452MHz</td> </tr> <tr> <td>Modulation Type:</td> <td>802.11b(DSSS):CCK,DQPSK,DBPSK 802.11g(OFDM):BPSK,QPSK,16-QAM,64-QAM 802.11n(OFDM):BPSK,QPSK,16-QAM,64-QAM</td> </tr> <tr> <td>Bit Rate of Transmitter:</td> <td>802.11b:11/5.5/2/1 Mbps 802.11g:54/48/36/24/18/12/9/6Mbps 802.11n(20MHz): 65/58.5/52/39/26/19.5/13/6.5Mbps 802.11n(40MHz): 135/121.5/108/81/54/40.5/37/13.5Mbps</td> </tr> <tr> <td>Number of Channel:</td> <td>802.11b/g/n20: 11CH 802.11n 40: 7CH</td> </tr> <tr> <td>Antenna Designation:</td> <td>Please see Note 4.</td> </tr> <tr> <td>AntennaGain (dBi):</td> <td>PCB Antenna: 2 dBi External Antenna: 3.5 dBi</td> </tr> <tr> <td>Duty Cycle:</td> <td>>98%</td> </tr> </table>	Operation Frequency:	802.11b/g/n 20: 2412~2462 MHz 802.11n(40MHz):2422~2452MHz	Modulation Type:	802.11b(DSSS):CCK,DQPSK,DBPSK 802.11g(OFDM):BPSK,QPSK,16-QAM,64-QAM 802.11n(OFDM):BPSK,QPSK,16-QAM,64-QAM	Bit Rate of Transmitter:	802.11b:11/5.5/2/1 Mbps 802.11g:54/48/36/24/18/12/9/6Mbps 802.11n(20MHz): 65/58.5/52/39/26/19.5/13/6.5Mbps 802.11n(40MHz): 135/121.5/108/81/54/40.5/37/13.5Mbps	Number of Channel:	802.11b/g/n20: 11CH 802.11n 40: 7CH	Antenna Designation:	Please see Note 4.	AntennaGain (dBi):	PCB Antenna: 2 dBi External Antenna: 3.5 dBi	Duty Cycle:	>98%
Operation Frequency:	802.11b/g/n 20: 2412~2462 MHz 802.11n(40MHz):2422~2452MHz														
Modulation Type:	802.11b(DSSS):CCK,DQPSK,DBPSK 802.11g(OFDM):BPSK,QPSK,16-QAM,64-QAM 802.11n(OFDM):BPSK,QPSK,16-QAM,64-QAM														
Bit Rate of Transmitter:	802.11b:11/5.5/2/1 Mbps 802.11g:54/48/36/24/18/12/9/6Mbps 802.11n(20MHz): 65/58.5/52/39/26/19.5/13/6.5Mbps 802.11n(40MHz): 135/121.5/108/81/54/40.5/37/13.5Mbps														
Number of Channel:	802.11b/g/n20: 11CH 802.11n 40: 7CH														
Antenna Designation:	Please see Note 4.														
AntennaGain (dBi):	PCB Antenna: 2 dBi External Antenna: 3.5 dBi														
Duty Cycle:	>98%														
Channel List	Please refer to the Note 2.														
Power Rating	DC 3.3V														
Hardware version number	Rev 1.2														
Software versionnumber	V1.0.1.2														
Connecting I/O Port(s)	Please refer to the User's Manual														

Note:

- 1 For a more detailed features description, please refer to the manufacturer's specifications or the User's Manual.



2

Operation Frequency of channel			
802.11b/g/n(20MHz)		Channel List for 802.11n(40MHz)	
Channel	Frequency	Channel	Frequency
01	2412	03	2422
02	2417	04	2427
03	2422	05	2432
04	2427	06	2437
05	2432	07	2442
06	2437	08	2447
07	2442	09	2452
08	2447		
09	2452		
10	2457		
11	2462		

3

Note:

In section 15.31(m), regards to the operating frequency range over 10 MHz, the Lowest frequency, the middle frequency, and the highest frequency of channel were selected to perform the test, and the selected channel see below:

Carrier Frequency Channel

2.4GHz Test Frequency:

For 802.11b/g/n (HT20)		For 802.11n (HT40)	
Channel	Freq.(MHz)	Channel	Freq.(MHz)
01	2412	03	2422
06	2437	06	2437
11	2462	09	2452

4

Ant.	Brand	Model Name	Antenna Type	Connector	Gain (dBi)	NOTE
1	WIZnet	WizFi360-PA	PCB; External	N/A	PCB Antenna: 2 dBi External Antenna: 3.5 dBi	WLAN Antenna



2.2 DESCRIPTION OF THE TEST MODES

Each of these EUT operation mode(s) or test configuration mode(s) mentioned above was evaluated respectively.

Worst Mode	Description	Data Rate
Mode 1	TX IEEE 802.11b CH1	1 Mbps
Mode 2	TX IEEE 802.11b CH6	1 Mbps
Mode 3	TX IEEE 802.11 b CH11	1 Mbps
Mode 4	TX IEEE 802.11g CH1	6 Mbps
Mode 5	TX IEEE 802.11g CH6	6 Mbps
Mode 6	TX IEEE 802.11g CH11	6 Mbps
Mode 7	TX IEEE 802.11n HT20 CH1	MCS 0
Mode 8	TX IEEE 802.11n HT20 CH6	MCS 0
Mode 9	TX IEEE 802.11n HT20 CH11	MCS 0
Mode 10	TX IEEE 802.11n HT40 CH3	MCS 0
Mode 11	TX IEEE 802.11n HT40 CH6	MCS 0
Mode 12	TX IEEE 802.11n HT40 CH9	MCS 0

Note:

The measurements are performed at all Bit Rate of Transmitter, the worst data was reported



2.3 BLOCK DIGRAM SHOWING THE CONFIGURATION OF SYSTEM TESTED

Radiation Test Set

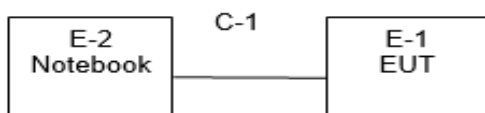

2.4 DESCRIPTION OF NECESSARY ACCESSORIES AND SUPPORT UNITS

The EUT has been tested as an independent unit together with other necessary accessories or support units. The following support units or accessories were used to form a representative test configuration during the tests.

Necessary accessories

Item	Equipment	Mfr/Brand	Model/Type No.	Serial No.	Note
E-1	N/A	N/A	N/A	N/A	N/A

Support units

Item	Equipment	Mfr/Brand	Model/Type No.	Serial No.	Note
E-2	Notebook	HP	500-320cx	N/A	N/A
C-1	USB Cable	N/A	100cm	N/A	N/A

Note:

- (1) The support equipment was authorized by Declaration of Confirmation.
- (2) For detachable type I/O cable should be specified the length in cm in 『Length』 column.
- (3) “YES” is means “shielded” “with core”; “NO” is means “unshielded” “without core”.



2.5 EQUIPMENTS LIST FOR ALL TEST ITEMS

Radiation Test equipment

Kind of Equipment	Manufacturer	Type No.	Serial No.	Last calibration	Calibrated until
Test Receiver	R&S	ESCI	101427	2018.10.13	2019.10.12
Signal Analyzer	Agilent	N9020A	MY51110105	2019.03.02	2020.03.01
Active loop Antenna	ZHINAN	ZN30900C	16035	2018.03.11	2021.03.10
Bilog Antenna	TESEQ	CBL6111D	34678	2017.11.02	2020.11.1
Horn Antenna	SCHWARZBECK	BBHA 9120D(1201)	9120D-1343	2018.10.19	2021.10.18
SHF-EHF Horn Antenna (18G-40GHz)	A-INFO	LB-180400-KF	J211020657	2018.03.11	2021.03.10
Pre-Amplifier(0.1M-3G Hz)	EM	EM330	060665	2018.10.13	2019.10.12
Pre-Amplifier (1G-18GHz)	SKET	LNPA-01018G-45	SK201808090 1	2018.10.13	2019.10.12
Temperature & Humidity	HH660	Mieo	N/A	2018.10.11	2019.10.10
turn table	EM	SC100_1	60531	N/A	N/A
Antenna mast	EM	SC100	N/A	N/A	N/A
Test SW	FARAD	EZ-EMC(Ver.STSLAB-03A1 RE)			

RF Connected Test

Kind of Equipment	Manufacturer	Type No.	Serial No.	Last calibration	Calibrated until
USB RF power sensor	DARE	RPR3006W	15I00041SNO03	2018.10.13	2019.10.12
Signal Analyzer	Agilent	N9020A	MY49100060	2018.10.13	2019.10.12
Temperature & Humidity	HH660	Mieo	N/A	2018.10.11	2019.10.10
Test SW	FARAD	LZ-RF /LzRf-3A3			



3. EMC EMISSION TEST

3.1 CONDUCTED EMISSION MEASUREMENT

3.1.1 POWER LINE CONDUCTED EMISSION LIMITS

operating frequency band. In case the emission fall within the restricted band specified on Part 15.207(a) limit in the table below has to be followed.

FREQUENCY (MHz)	Conducted Emissionlimit (dBuV)	
	Quasi-peak	Average
0.15 -0.5	66 - 56 *	56 - 46 *
0.50 -5.0	56.00	46.00
5.0 -30.0	60.00	50.00

Note:

- (1) The tighter limit applies at the band edges.
- (2) The limit of " * " marked band means the limitation decreases linearly with the logarithm of the frequency in the range.

The following table is the setting of the receiver

Receiver Parameters	Setting
Attenuation	10 dB
Start Frequency	0.15 MHz
Stop Frequency	30 MHz
IF Bandwidth	9 kHz

3.1.2 TEST PROCEDURE

- a. The EUT was 0.8 meters from the horizontal ground plane and 0.4 meters from the vertical ground plane with EUT being connected to the power mains through a line impedance stabilization network (LISN). All other support equipments powered from additional LISN(s). The LISN provide 50 Ohm/ 50uH of coupling impedance for the measuring instrument.
- b. Interconnecting cables that hang closer than 40 cm to the ground plane shall be folded back and forth in the center forming a bundle 30 to 40 cm long.
- c. I/O cables that are not connected to a peripheral shall be bundled in the center. The end of the cable may be terminated, if required, using the correct terminating impedance. The overall length shall not exceed 1 m.
- d. LISN at least 80 cm from nearest part of EUT chassis.
- e. For the actual test configuration, please refer to the related Item –EUT Test Photos.

3.1.3 TEST SETUP

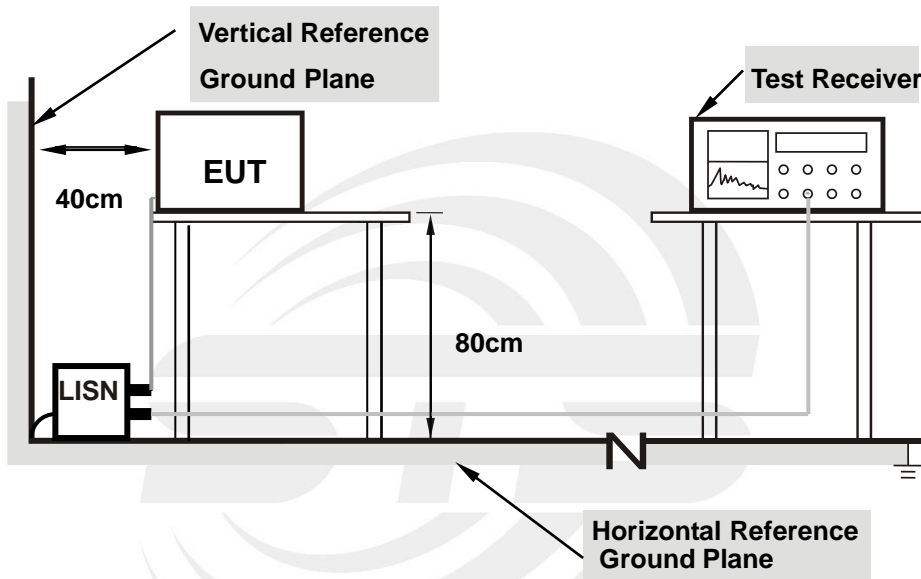

- Note: 1.Support units were connected to second LISN.**
2.Both of LISNs (AMN) are 80 cm from EUT and at least 80 from other units and other metal planes

3.1.4 TEST RESULT

Temperature:	25.2°C	Relative Humidity:	64%
Test Voltage:	AC 120V/60Hz	Phase:	L/N
Test Mode:	N/A		

Note: EUT is only power by battery, So it is not applicable for this test.



3.2 RADIATED EMISSION MEASUREMENT

3.2.1 RADIATED EMISSION LIMITS

in any 100 kHz bandwidth outside the operating frequency band. In case the emission fall within the Restricted band specified on Part15.205(a)&209(a) limit in the table and according to ANSI C63.10-2013 below has to be followed.

LIMITS OF RADIATED EMISSION MEASUREMENT (0.009MHz - 1000MHz)

Frequencies (MHz)	Field Strength (microlvolts/meter)	Measurement Distance (meters)
0.009~0.490	2400/F(KHz)	300
0.490~1.705	24000/F(KHz)	30
1.705~30.0	30	30
30~88	100	3
88~216	150	3
216~960	200	3
Above 960	500	3

LIMITS OF RADIATED EMISSION MEASUREMENT (1000MHz-25GHz)

FREQUENCY (MHz)	(dBuV/m) (at 3M)	
	PEAK	AVERAGE
Above 1000	74	54

Notes:

- (1) The limit for radiated test was performed according to FCC PART 15C.
- (2) The tighter limit applies at the band edges.
- (3) Emission level (dBuV/m)=20log Emission level (uV/m).

For Radiated Emission

Spectrum Parameter	Setting
Attenuation	Auto
Detector	Peak/AV
Start Frequency	1000 MHz(Peak/AV)
Stop Frequency	10th carrier hamonic(Peak/AV)
RB / VB (emission in restricted band)	1 MHz /3MHz

For Band edge

Spectrum Parameter	Setting
Detector	Peak/AV
Start/Stop Frequency	Lower Band Edge: 2300 to 2412 MHz Upper Band Edge: 2462to 2500 MHz
RB / VB (emission in restricted band)	1 MHz /3MHz



Receiver Parameter	Setting
Start ~ Stop Frequency	9kHz~90kHz / RB 200Hz for PK & AV
Start ~ Stop Frequency	90kHz~110kHz / RB 200Hz for QP
Start ~ Stop Frequency	110kHz~490kHz / RB 200Hz for PK & AV
Start ~ Stop Frequency	490kHz~30MHz / RB 9kHz for QP
Start ~ Stop Frequency	30MHz~1000MHz / RB 120kHz for QP

3.2.2 TEST PROCEDURE

- a. The measuring distance of at 3 m shall be used for measurements at frequency 0.009MHz up to 1GHz, and above 1GHz
- b. The EUT was placed on the top of a rotating table 0.8 meters(above 1GHz is 1.5 m) above the ground at a 3 meter anechoic chamber. The table was rotated 360 degrees to determine the position of the highest radiation.
- c. The height of the equipment shall be 0.8 m(above 1GHz is 1.5 m); the height of the test antenna shall vary between 1 m to 4 m. Horizontal and vertical polarizations of the antenna are set to make the measurement
- d. The initial step in collecting conducted emission data is a spectrum analyzer peak detector mode pre-scanning the measurement frequency range. Significant peaks are then marked and then Quasi Peak detector mode re-measured.
- e. If the Peak Mode measured value compliance with and lower than Quasi Peak Mode Limit, the EUT shall be deemed to meet QP Limits and then no additional QP Mode measurement performed.
- f. For the actual test configuration, please refer to the related Item –EUT Test Photos.

Note:

Both horizontal and vertical antenna polarities were tested and performed test to three orthogonal axis. The worst case emissions were reported

3.2.3 TEST SETUP

(A) Radiated Emission Test-Up Frequency Below 30MHz

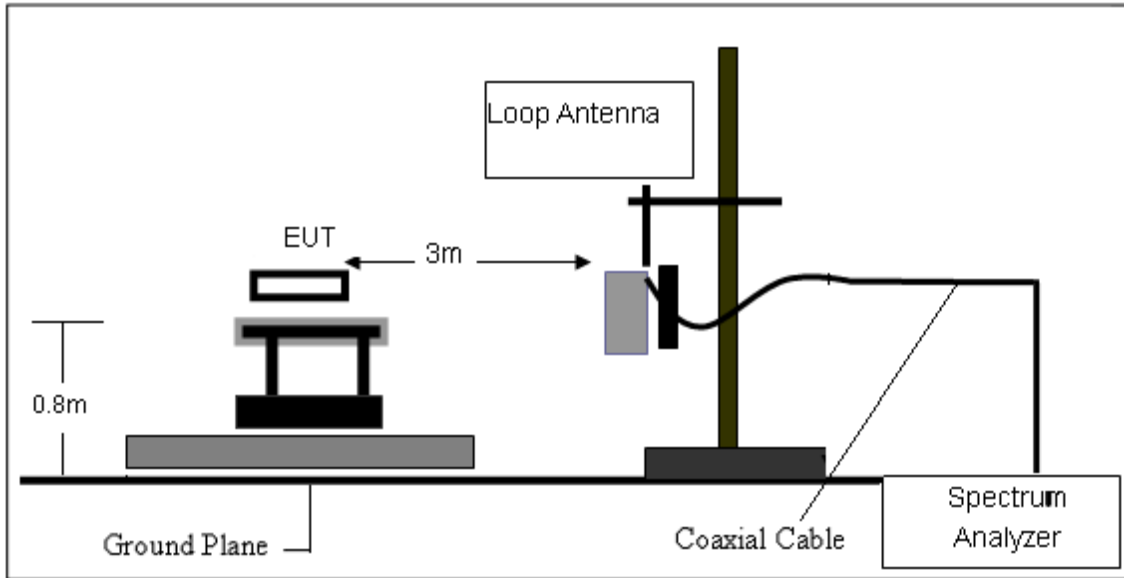

(B) Radiated Emission Test-Up Frequency 30MHz~1GHz

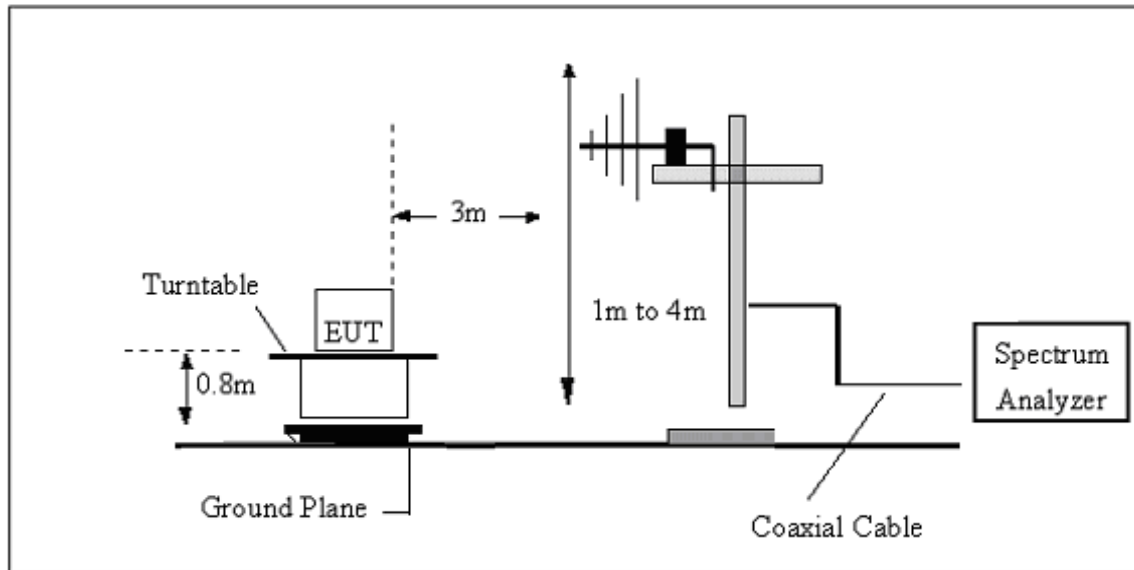

(C) Radiated Emission Test-Up Frequency Above 1GHz

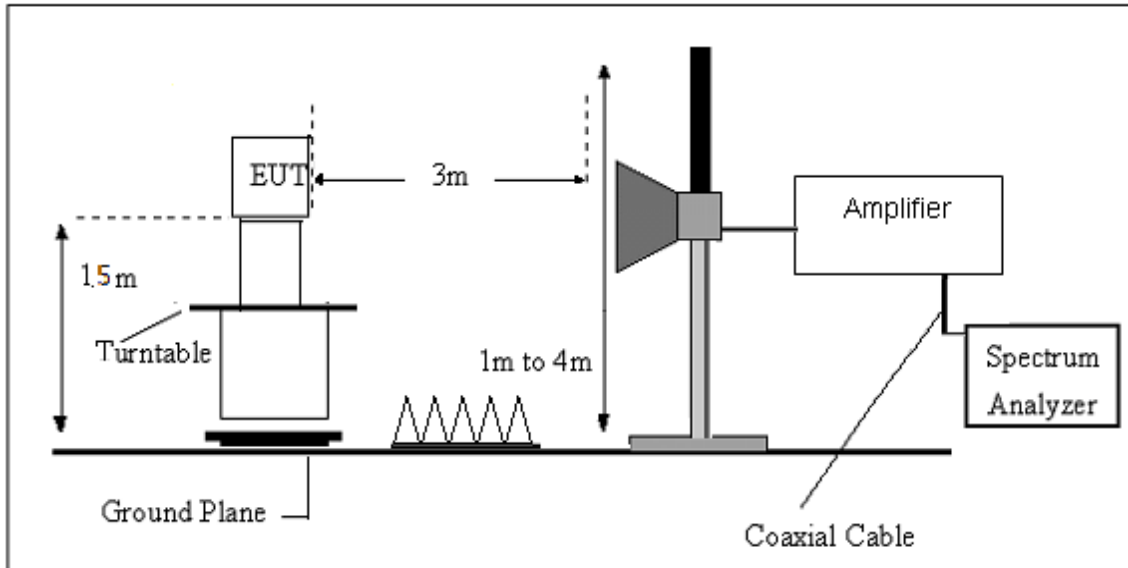

3.2.4 EUT OPERATING CONDITIONS

The EUT tested system was configured as the statements of 2.3 Unless otherwise a special operating condition is specified in the follows during the testing.

3.2.5 FIELD STRENGTH CALCULATION

The field strength is calculated by adding the Antenna Factor and Cable Factor and subtracting the Amplifier Gain and Duty Cycle Correction Factor (if any) from the measured reading. The basic equation with a sample calculation is as follows:

$$FS = RA + AF + CL - AG$$

Where

FS = Field Strength

CL = Cable Attenuation Factor (Cable Loss)

RA = Reading Amplitude

AG = Amplifier Gain

AF = Antenna Factor

For example

Frequency (MHz)	FS (dBμV/m)	RA (dBμV/m)	AF (dB)	CL (dB)	AG (dB)	Factor (dB)
300	40	58.1	12.2	1.6	31.9	-18.1

$$\text{Factor} = \text{AF} + \text{CL} - \text{AG}$$



3.2.6 TEST RESULT

9KHz-30MHz

Temperature:	22.7°C	Relative Humidity:	61%
Test Voltage:	DC 3.3V	Polarization:	--
Test Mode:	TX Mode		

Freq. (MHz)	Reading (dBuV/m)	Limit (dBuV/m)	Margin (dB)	State P/F	Test Result
--	--	--	--	--	PASS
--	--	--	--	--	PASS

Note:

The amplitude of spurious emissions which are attenuated by more than 20dB below the permissible value has no need to be reported.

Distance extrapolation factor = $40 \log (\text{specific distance}/\text{test distance})$ (dB);

Limit line = specific limits(dBuv) + distance extrapolation factor.

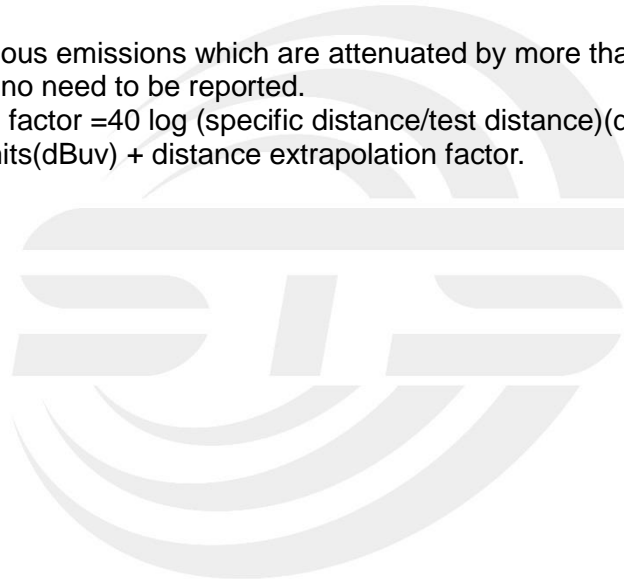



(30MHz - 1000MHz)

External Antenna

Temperature:	22.7°C	Relative Humidity:	61%
Test Voltage:	DC 3.3V	Polarization:	Horizontal
Test Mode:	Mode 1/2/3/4/5/6/7/8/9/10/11/12 (Mode 5 worst mode)		

No.	Frequency (MHz)	Reading (dBuV)	Correct Factor(dB/m)	Result (dBuV/m)	Limit (dBuV/m)	Margin (dB)	Remark
1	31.2893	32.81	-13.05	19.76	40.00	-20.24	QP
2	64.6594	42.83	-25.43	17.40	40.00	-22.60	QP
3	145.8610	41.90	-18.61	23.29	43.50	-20.21	QP
4	351.7078	35.62	-13.84	21.78	46.00	-24.22	QP
5	472.1760	38.74	-10.22	28.52	46.00	-17.48	QP
6	993.0113	33.01	-0.27	32.74	54.00	-21.26	QP

Remark:

1. Margin = Result (Result = Reading + Factor) – Limit

80.0 dBuV/m

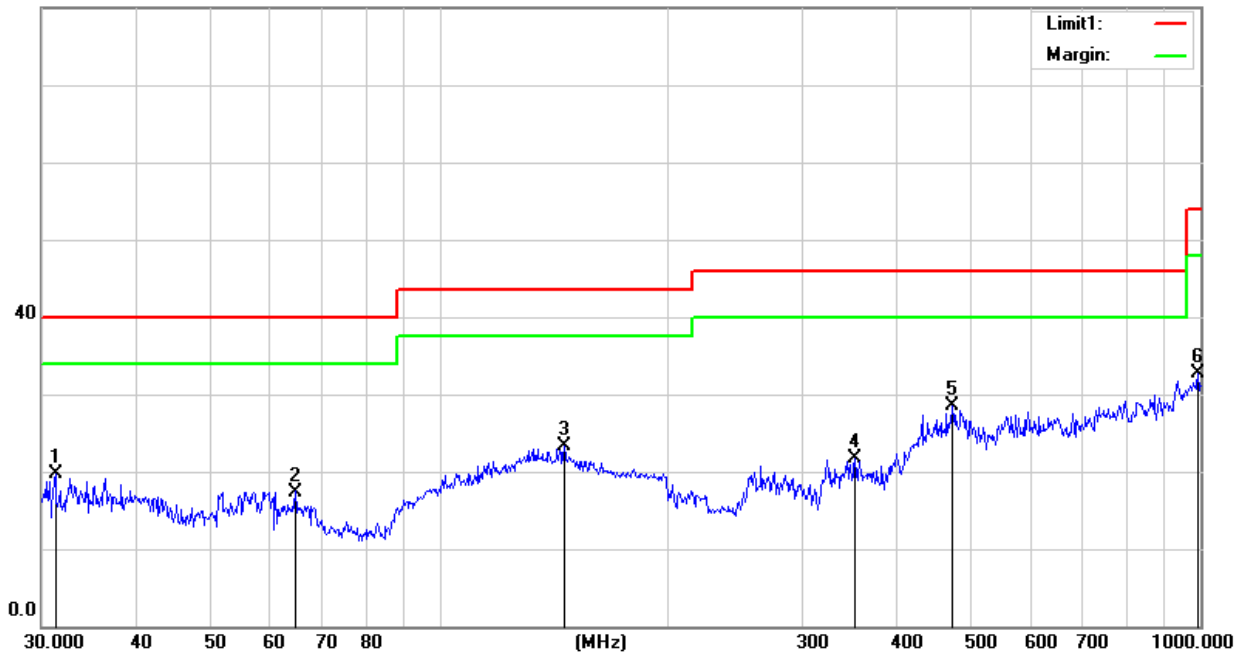



Temperature:	22.7°C	Relative Humidity:	61%
Test Voltage:	DC 3.3V	Polarization:	Vertical
Test Mode:	Mode 1/2/3/4/5/6/7/8/9/10/11/12 (Mode 5 worst mode)		

No.	Frequency (MHz)	Reading (dBuV)	Correct Factor(dB/m)	Result (dBuV/m)	Limit (dBuV/m)	Margin (dB)	Remark
1	31.2893	36.81	-13.05	23.76	40.00	-16.24	QP
2	83.5220	45.87	-22.44	23.43	40.00	-16.57	QP
3	96.4360	45.61	-20.67	24.94	43.50	-18.56	QP
4	264.7456	36.26	-15.46	20.80	46.00	-25.20	QP
5	554.8251	35.39	-7.21	28.18	46.00	-17.82	QP
6	993.0113	33.01	-0.27	32.74	54.00	-21.26	QP

Remark:.

1. Margin = Result (Result =Reading + Factor)–Limit

80.0 dBuV/m

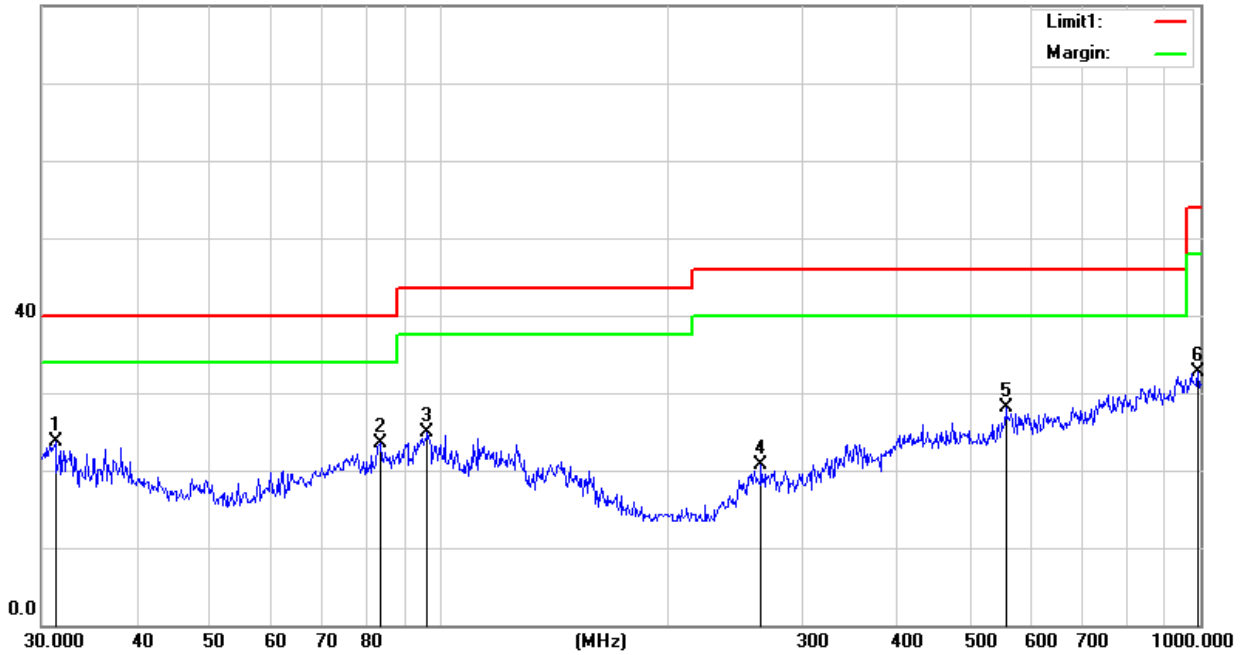



PCB Antenna

Temperature:	22.7°C	Relative Humidity:	61%
Test Voltage:	DC 3.3V	Polarization:	Horizontal
Test Mode:	Mode 1/2/3/4/5/6/7/8/9/10/11/12 (Mode 5 worst mode)		

No.	Frequency (MHz)	Reading (dBuV)	Correct Factor (dB/m)	Result (dBuV/m)	Limit (dBuV/m)	Margin (dB)	Remark
1	31.2893	34.81	-13.05	21.76	40.00	-18.24	QP
2	52.3913	39.40	-23.88	15.52	40.00	-24.48	QP
3	112.5242	41.01	-18.91	22.10	43.50	-21.40	QP
4	323.3204	35.73	-14.75	20.98	46.00	-25.02	QP
5	564.6390	36.47	-7.17	29.30	46.00	-16.70	QP
6	932.2713	33.59	-1.48	32.11	46.00	-13.89	QP

Remark:

1. Margin = Result (Result = Reading + Factor) - Limit

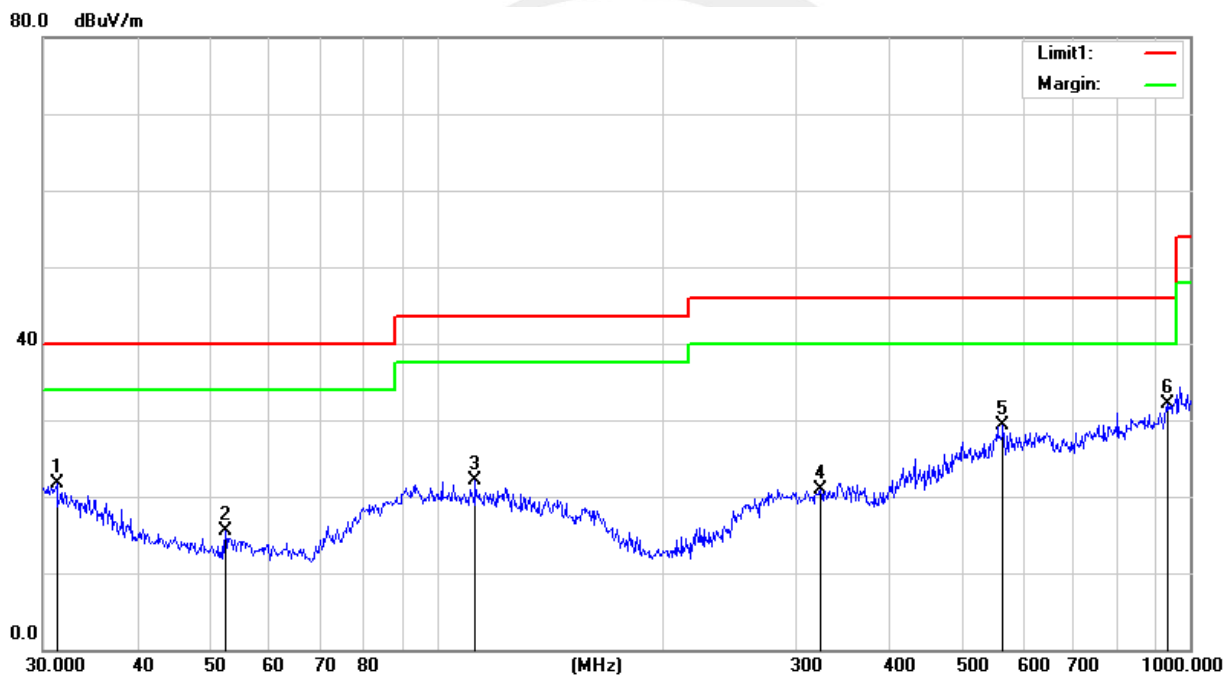



Temperature:	22.7°C	Relative Humidity:	61%
Test Voltage:	DC 3.3V	Polarization:	Vertical
Test Mode:	Mode 1/2/3/4/5/6/7/8/9/10/11/12 (Mode 5 worst mode)		

No.	Frequency (MHz)	Reading (dBuV)	Correct Factor(dB/m)	Result (dBuV/m)	Limit (dBuV/m)	Margin (dB)	Remark
1	31.2893	33.81	-13.05	20.76	40.00	-19.24	QP
2	66.4990	38.49	-25.33	13.16	40.00	-26.84	QP
3	112.5242	40.01	-18.91	21.10	43.50	-22.40	QP
4	264.7456	35.26	-15.46	19.80	46.00	-26.20	QP
5	554.8252	36.89	-7.21	29.68	46.00	-16.32	QP
6	958.7943	33.40	-0.52	32.88	46.00	-13.12	QP

Remark:.

1. Margin = Result (Result =Reading + Factor)–Limit

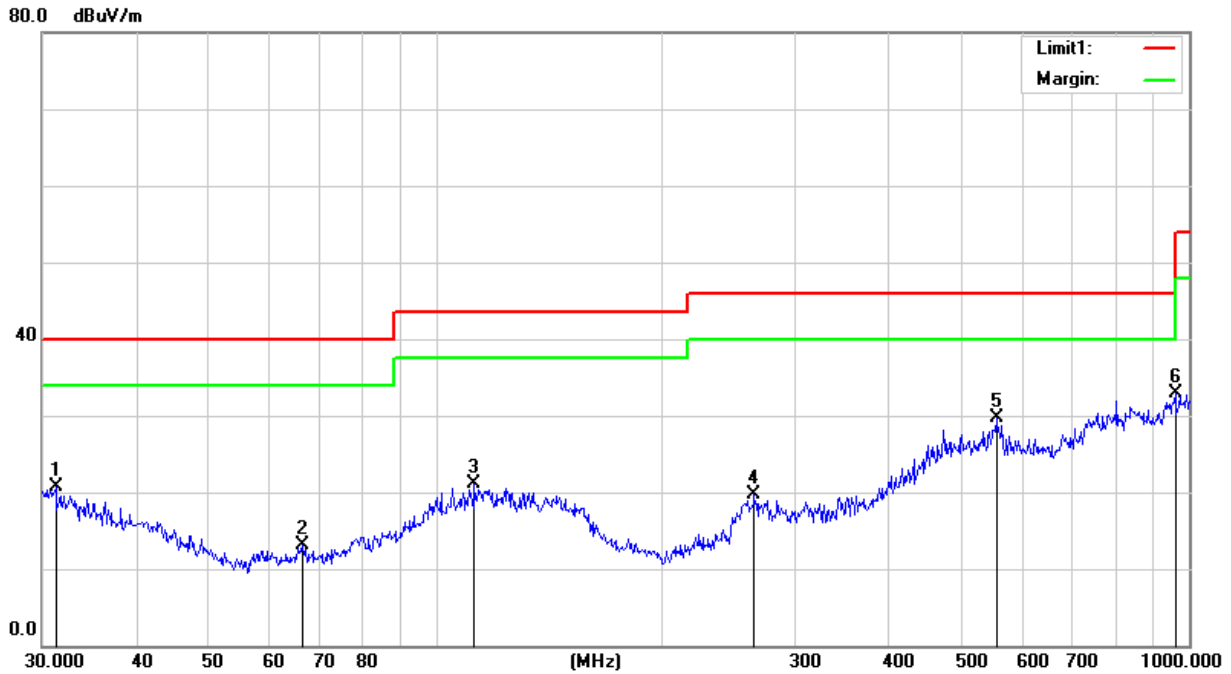



(1000MHz-25GHz) Restricted band and Spurious emission Requirements

External Antenna

802.11 g

Frequency (MHz)	Meter Reading (dBμV)	Amplifier (dB)	Loss (dB)	Antenna Factor (dB/m)	Orrected Factor (dB)	Emission Level (dBμV/m)	Limits (dBμV/m)	Margin (dB)	Detector Type	Comment
Low Channel (2412 MHz)										
3264.66	61.94	44.70	6.70	28.20	-9.80	52.14	74.00	-21.86	PK	Vertical
3264.66	50.50	44.70	6.70	28.20	-9.80	40.70	54.00	-13.30	AV	Vertical
3264.66	61.19	44.70	6.70	28.20	-9.80	51.39	74.00	-22.61	PK	Horizontal
3264.66	50.85	44.70	6.70	28.20	-9.80	41.05	54.00	-12.95	AV	Horizontal
4824.29	58.88	44.20	9.04	31.60	-3.56	55.32	74.00	-18.68	PK	Vertical
4824.29	50.05	44.20	9.04	31.60	-3.56	46.49	54.00	-7.51	AV	Vertical
4824.33	59.17	44.20	9.04	31.60	-3.56	55.61	74.00	-18.39	PK	Horizontal
4824.33	50.40	44.20	9.04	31.60	-3.56	46.84	54.00	-7.16	AV	Horizontal
5359.75	48.70	44.20	9.86	32.00	-2.34	46.36	74.00	-27.64	PK	Vertical
5359.75	39.20	44.20	9.86	32.00	-2.34	36.86	54.00	-17.14	AV	Vertical
5359.77	47.21	44.20	9.86	32.00	-2.34	44.87	74.00	-29.13	PK	Horizontal
5359.77	38.69	44.20	9.86	32.00	-2.34	36.35	54.00	-17.65	AV	Horizontal
7235.70	53.62	43.50	11.40	35.50	3.40	57.02	74.00	-16.98	PK	Vertical
7235.70	44.72	43.50	11.40	35.50	3.40	48.12	54.00	-5.88	AV	Vertical
7235.72	54.84	43.50	11.40	35.50	3.40	58.24	74.00	-15.76	PK	Horizontal
7235.79	44.58	43.50	11.40	35.50	3.40	47.98	54.00	-6.02	AV	Vertical
Middle Channel (2437 MHz)										
3264.78	61.05	44.70	6.70	28.20	-9.80	51.25	74.00	-22.75	PK	Vertical
3264.78	50.70	44.70	6.70	28.20	-9.80	40.90	54.00	-13.10	AV	Vertical
3264.62	61.38	44.70	6.70	28.20	-9.80	51.58	74.00	-22.42	PK	Horizontal
3264.62	50.52	44.70	6.70	28.20	-9.80	40.72	54.00	-13.28	AV	Horizontal
4874.32	59.31	44.20	9.04	31.60	-3.56	55.75	74.00	-18.25	PK	Vertical
4874.32	50.41	44.20	9.04	31.60	-3.56	46.85	54.00	-7.15	AV	Vertical
4874.58	58.51	44.20	9.04	31.60	-3.56	54.95	74.00	-19.05	PK	Horizontal
4874.58	50.17	44.20	9.04	31.60	-3.56	46.61	54.00	-7.39	AV	Horizontal
5359.65	48.30	44.20	9.86	32.00	-2.34	45.96	74.00	-28.04	PK	Vertical
5359.65	39.77	44.20	9.86	32.00	-2.34	37.43	54.00	-16.57	AV	Vertical
5359.57	47.61	44.20	9.86	32.00	-2.34	45.27	74.00	-28.73	PK	Horizontal
5359.57	38.87	44.20	9.86	32.00	-2.34	36.53	54.00	-17.47	AV	Horizontal
7310.80	54.37	43.50	11.40	35.50	3.40	57.77	74.00	-16.23	PK	Vertical
7310.80	43.88	43.50	11.40	35.50	3.40	47.28	54.00	-6.72	AV	Vertical
7310.83	53.73	43.50	11.40	35.50	3.40	57.13	74.00	-16.87	PK	Horizontal
7310.83	44.65	43.50	11.40	35.50	3.40	48.05	54.00	-5.95	AV	Horizontal



High Channel (2462 MHz)										
3264.80	60.88	44.70	6.70	28.20	-9.80	51.08	74.00	-22.92	PK	Vertical
3264.80	50.13	44.70	6.70	28.20	-9.80	40.33	54.00	-13.67	AV	Vertical
3264.81	61.93	44.70	6.70	28.20	-9.80	52.13	74.00	-21.87	PK	Horizontal
3264.81	50.52	44.70	6.70	28.20	-9.80	40.72	54.00	-13.28	AV	Horizontal
4924.45	58.90	44.20	9.04	31.60	-3.56	55.34	74.00	-18.66	PK	Vertical
4924.45	49.98	44.20	9.04	31.60	-3.56	46.42	54.00	-7.58	AV	Vertical
4924.47	58.92	44.20	9.04	31.60	-3.56	55.36	74.00	-18.64	PK	Horizontal
4924.47	49.89	44.20	9.04	31.60	-3.56	46.33	54.00	-7.67	AV	Horizontal
5359.71	48.83	44.20	9.86	32.00	-2.34	46.49	74.00	-27.51	PK	Vertical
5359.71	39.69	44.20	9.86	32.00	-2.34	37.35	54.00	-16.65	AV	Vertical
5359.87	47.68	44.20	9.86	32.00	-2.34	45.34	74.00	-28.66	PK	Horizontal
5359.87	38.81	44.20	9.86	32.00	-2.34	36.47	54.00	-17.53	AV	Horizontal
7385.83	54.31	43.50	11.40	35.50	3.40	57.71	74.00	-16.29	PK	Vertical
7385.83	44.05	43.50	11.40	35.50	3.40	47.45	54.00	-6.55	AV	Vertical
7385.86	54.66	43.50	11.40	35.50	3.40	58.06	74.00	-15.94	PK	Horizontal
7385.86	43.53	43.50	11.40	35.50	3.40	46.93	54.00	-7.07	AV	Horizontal

Remark:

- Factor = Antenna Factor + Cable Loss – Pre-amplifier.
- Scan with 802.11b, 802.11g, 802.11n (HT-20), 802.11n (HT-40) the worst case is 802.11g.
Emission Level = Reading + Factor
Margin = Limit - Emission Level
- The frequency emission of peak points that did not show above the forms are at least 20dB below the limit, the frequency emission is mainly from the environment noise.



PCB Antenna

802.11 g

Frequency (MHz)	Meter Reading (dBμV)	Amplifier (dB)	Loss (dB)	Antenna Factor (dB/m)	Orrected Factor (dB)	Emission Level (dBμV/m)	Limits (dBμV/m)	Margin (dB)	Detector Type	Comment
Low Channel (2412 MHz)										
3264.71	62.10	44.70	6.70	28.20	-9.80	52.30	74.00	-21.70	PK	Vertical
3264.71	49.84	44.70	6.70	28.20	-9.80	40.04	54.00	-13.96	AV	Vertical
3264.77	61.94	44.70	6.70	28.20	-9.80	52.14	74.00	-21.86	PK	Horizontal
3264.77	50.29	44.70	6.70	28.20	-9.80	40.49	54.00	-13.51	AV	Horizontal
4824.42	58.96	44.20	9.04	31.60	-3.56	55.40	74.00	-18.60	PK	Vertical
4824.42	49.55	44.20	9.04	31.60	-3.56	45.99	54.00	-8.01	AV	Vertical
4824.48	58.63	44.20	9.04	31.60	-3.56	55.07	74.00	-18.93	PK	Horizontal
4824.48	49.50	44.20	9.04	31.60	-3.56	45.94	54.00	-8.06	AV	Horizontal
5359.68	48.50	44.20	9.86	32.00	-2.34	46.16	74.00	-27.84	PK	Vertical
5359.68	40.42	44.20	9.86	32.00	-2.34	38.08	54.00	-15.92	AV	Vertical
5359.73	48.03	44.20	9.86	32.00	-2.34	45.69	74.00	-28.31	PK	Horizontal
5359.73	38.94	44.20	9.86	32.00	-2.34	36.60	54.00	-17.40	AV	Horizontal
7235.83	54.57	43.50	11.40	35.50	3.40	57.97	74.00	-16.03	PK	Vertical
7235.83	43.56	43.50	11.40	35.50	3.40	46.96	54.00	-7.04	AV	Vertical
7235.68	53.50	43.50	11.40	35.50	3.40	56.90	74.00	-17.10	PK	Horizontal
7235.96	43.76	43.50	11.40	35.50	3.40	47.16	54.00	-6.84	AV	Vertical
Middle Channel (2437 MHz)										
3264.63	62.03	44.70	6.70	28.20	-9.80	52.23	74.00	-21.77	PK	Vertical
3264.63	49.87	44.70	6.70	28.20	-9.80	40.07	54.00	-13.93	AV	Vertical
3264.73	61.21	44.70	6.70	28.20	-9.80	51.41	74.00	-22.59	PK	Horizontal
3264.73	50.73	44.70	6.70	28.20	-9.80	40.93	54.00	-13.07	AV	Horizontal
4874.47	58.59	44.20	9.04	31.60	-3.56	55.03	74.00	-18.97	PK	Vertical
4874.47	50.58	44.20	9.04	31.60	-3.56	47.02	54.00	-6.98	AV	Vertical
4874.44	58.19	44.20	9.04	31.60	-3.56	54.63	74.00	-19.37	PK	Horizontal
4874.44	49.10	44.20	9.04	31.60	-3.56	45.54	54.00	-8.46	AV	Horizontal
5359.72	49.10	44.20	9.86	32.00	-2.34	46.76	74.00	-27.24	PK	Vertical
5359.72	39.78	44.20	9.86	32.00	-2.34	37.44	54.00	-16.56	AV	Vertical
5359.65	47.71	44.20	9.86	32.00	-2.34	45.37	74.00	-28.63	PK	Horizontal
5359.65	39.52	44.20	9.86	32.00	-2.34	37.18	54.00	-16.82	AV	Horizontal
7310.77	54.14	43.50	11.40	35.50	3.40	57.54	74.00	-16.46	PK	Vertical
7310.77	43.65	43.50	11.40	35.50	3.40	47.05	54.00	-6.95	AV	Vertical
7310.67	53.77	43.50	11.40	35.50	3.40	57.17	74.00	-16.83	PK	Horizontal
7310.67	44.11	43.50	11.40	35.50	3.40	47.51	54.00	-6.49	AV	Horizontal



High Channel (2462 MHz)										
3264.62	61.36	44.70	6.70	28.20	-9.80	51.56	74.00	-22.44	PK	Vertical
3264.62	51.46	44.70	6.70	28.20	-9.80	41.66	54.00	-12.34	AV	Vertical
3264.57	61.30	44.70	6.70	28.20	-9.80	51.50	74.00	-22.50	PK	Horizontal
3264.57	50.32	44.70	6.70	28.20	-9.80	40.52	54.00	-13.48	AV	Horizontal
4924.39	58.89	44.20	9.04	31.60	-3.56	55.33	74.00	-18.67	PK	Vertical
4924.39	49.47	44.20	9.04	31.60	-3.56	45.91	54.00	-8.09	AV	Vertical
4924.43	58.17	44.20	9.04	31.60	-3.56	54.61	74.00	-19.39	PK	Horizontal
4924.43	49.70	44.20	9.04	31.60	-3.56	46.14	54.00	-7.86	AV	Horizontal
5359.63	49.19	44.20	9.86	32.00	-2.34	46.85	74.00	-27.15	PK	Vertical
5359.63	39.95	44.20	9.86	32.00	-2.34	37.61	54.00	-16.39	AV	Vertical
5359.64	47.66	44.20	9.86	32.00	-2.34	45.32	74.00	-28.68	PK	Horizontal
5359.64	38.93	44.20	9.86	32.00	-2.34	36.59	54.00	-17.41	AV	Horizontal
7385.93	54.90	43.50	11.40	35.50	3.40	58.30	74.00	-15.70	PK	Vertical
7385.93	44.26	43.50	11.40	35.50	3.40	47.66	54.00	-6.34	AV	Vertical
7385.66	53.80	43.50	11.40	35.50	3.40	57.20	74.00	-16.80	PK	Horizontal
7385.66	44.11	43.50	11.40	35.50	3.40	47.51	54.00	-6.49	AV	Horizontal

Remark:

- Factor = Antenna Factor + Cable Loss – Pre-amplifier.
- Scan with 802.11b, 802.11g, 802.11n (HT-20), 802.11n (HT-40) the worst case is 802.11g.
Emission Level = Reading + Factor
Margin = Limit - Emission Level
- The frequency emission of peak points that did not show above the forms are at least 20dB below the limit, the frequency emission is mainly from the environment noise.



3.2.6 TEST RESULTS(Band edge Requirements)

External Antenna
802.11g-Low
Horizontal

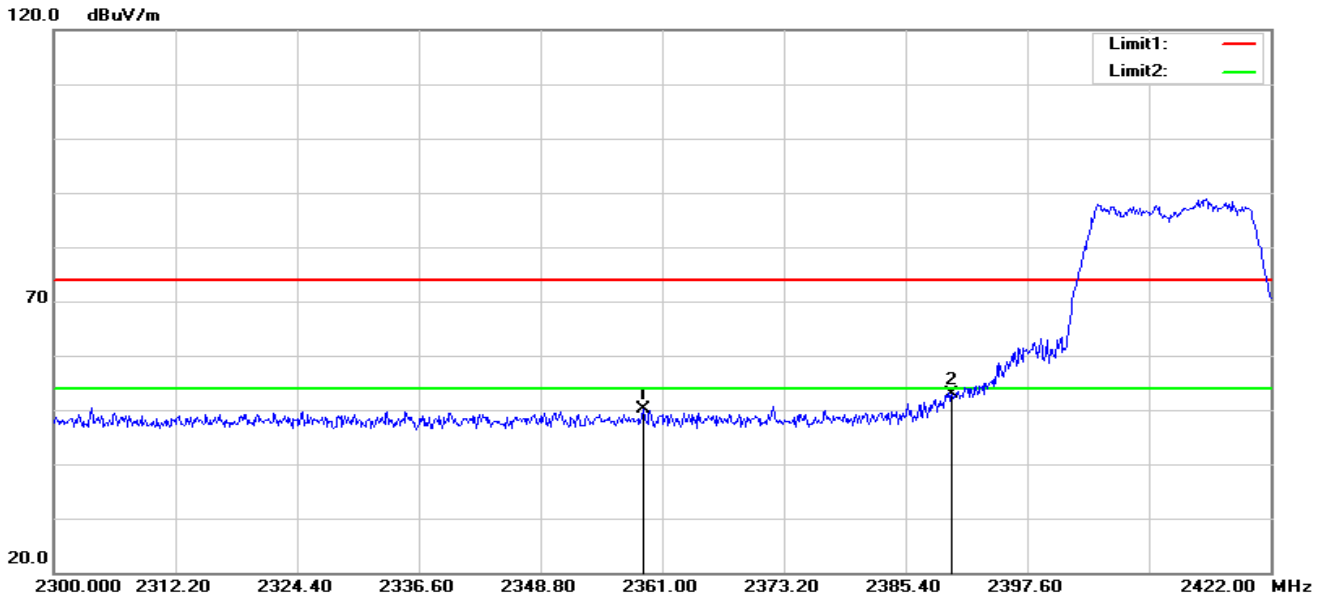

No.	Frequency (MHz)	Reading (dBuV)	Correct Factor(dB/m)	Result (dBuV/m)	Limit (dBuV/m)	Margin (dB)	Remark
1	2359.170	60.82	-10.69	50.13	74.00	-23.87	peak
2	2390.000	63.42	-10.48	52.94	74.00	-21.06	peak

Vertical

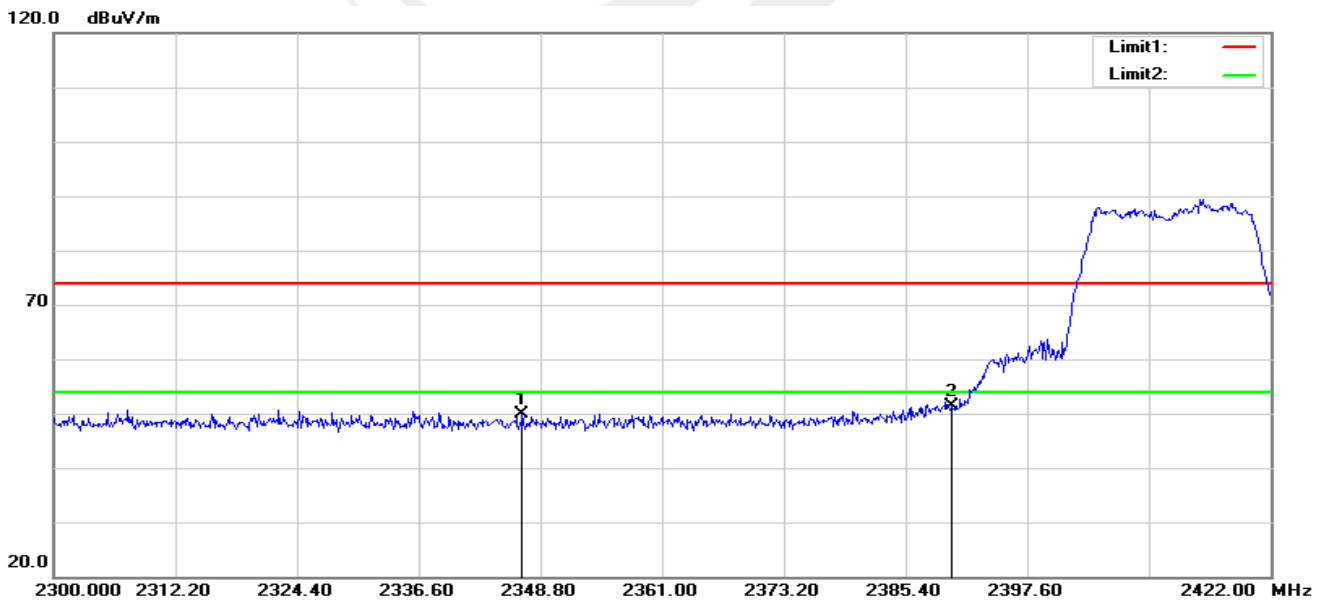

No.	Frequency (MHz)	Reading (dBuV)	Correct Factor(dB/m)	Result (dBuV/m)	Limit (dBuV/m)	Margin (dB)	Remark
1	2346.970	60.71	-10.76	49.95	74.00	-24.05	peak
2	2390.000	61.77	-10.48	51.29	74.00	-22.71	peak



802.11g-High Horizontal

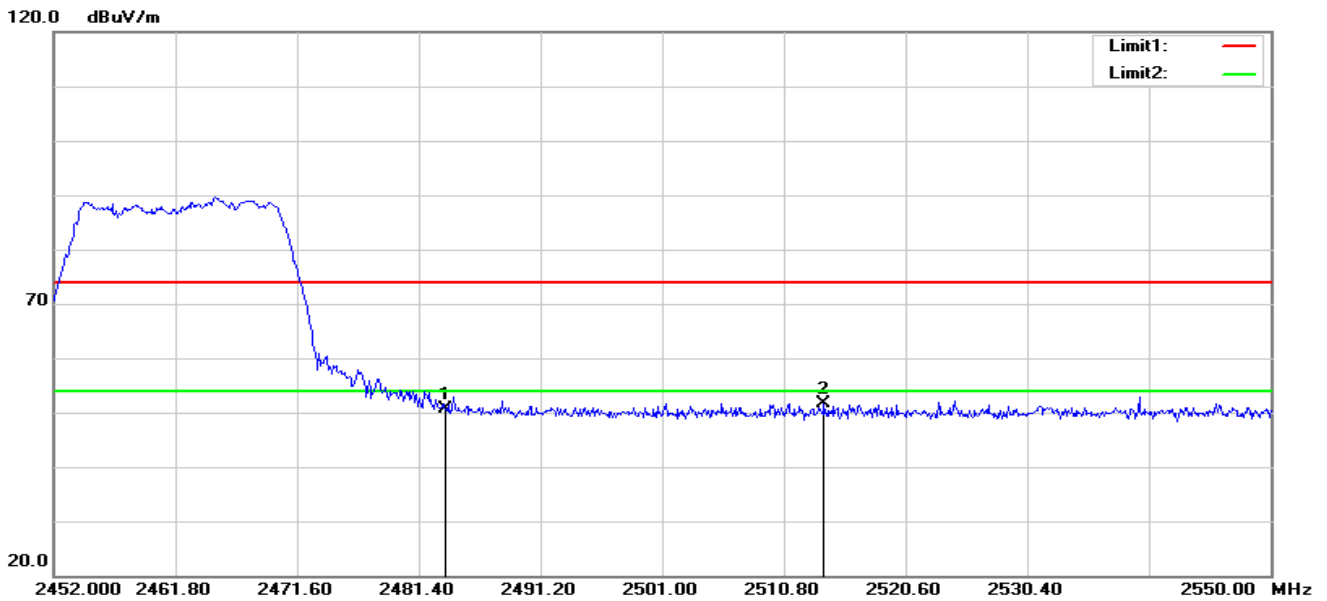

No.	Frequency (MHz)	Reading (dBuV)	Correct Factor(dB/m)	Result (dBuV/m)	Limit (dBuV/m)	Margin (dB)	Remark
1	2483.500	60.55	-9.99	50.56	74.00	-23.44	peak
2	2514.034	61.40	-9.87	51.53	74.00	-22.47	peak

Vertical

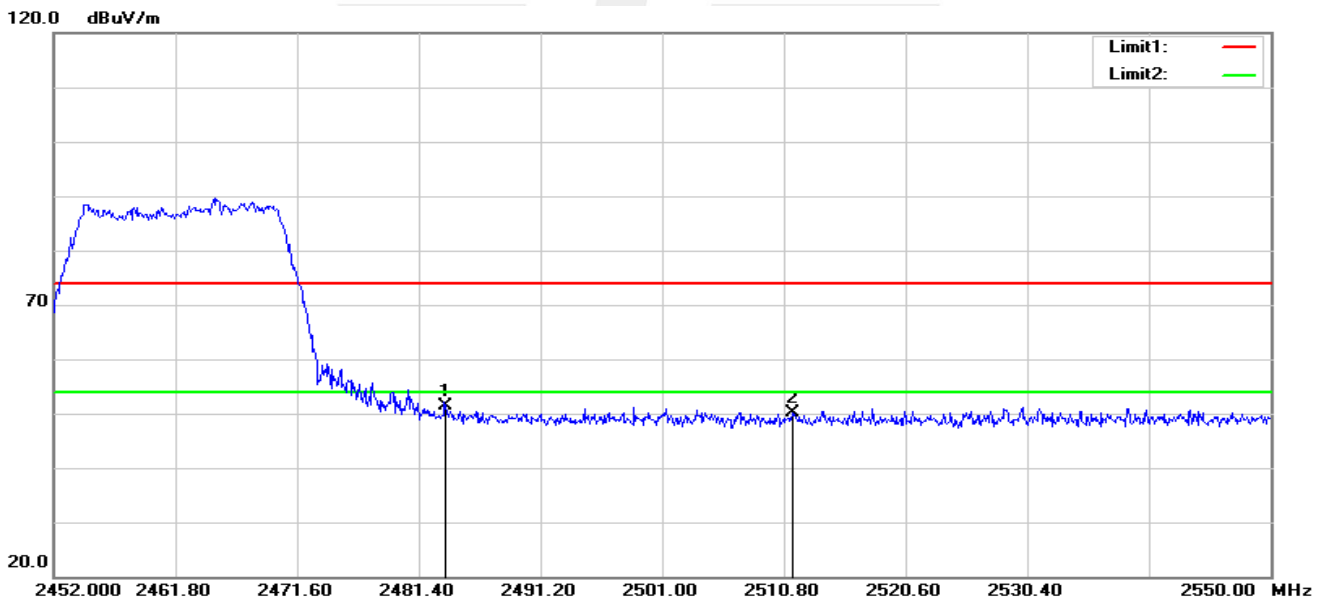

No.	Frequency (MHz)	Reading (dBuV)	Correct Factor(dB/m)	Result (dBuV/m)	Limit (dBuV/m)	Margin (dB)	Remark
1	2483.500	61.37	-9.99	51.38	74.00	-22.62	peak
2	2511.486	60.08	-9.87	50.21	74.00	-23.79	peak

Note: 802.11b, 802.11g, 802.11n (HT-20), 802.11n (HT-40) mode all have been tested, the worst case is 802.11g, only show the worst case.



PCB Antenna
802.11g-Low
 Horizontal

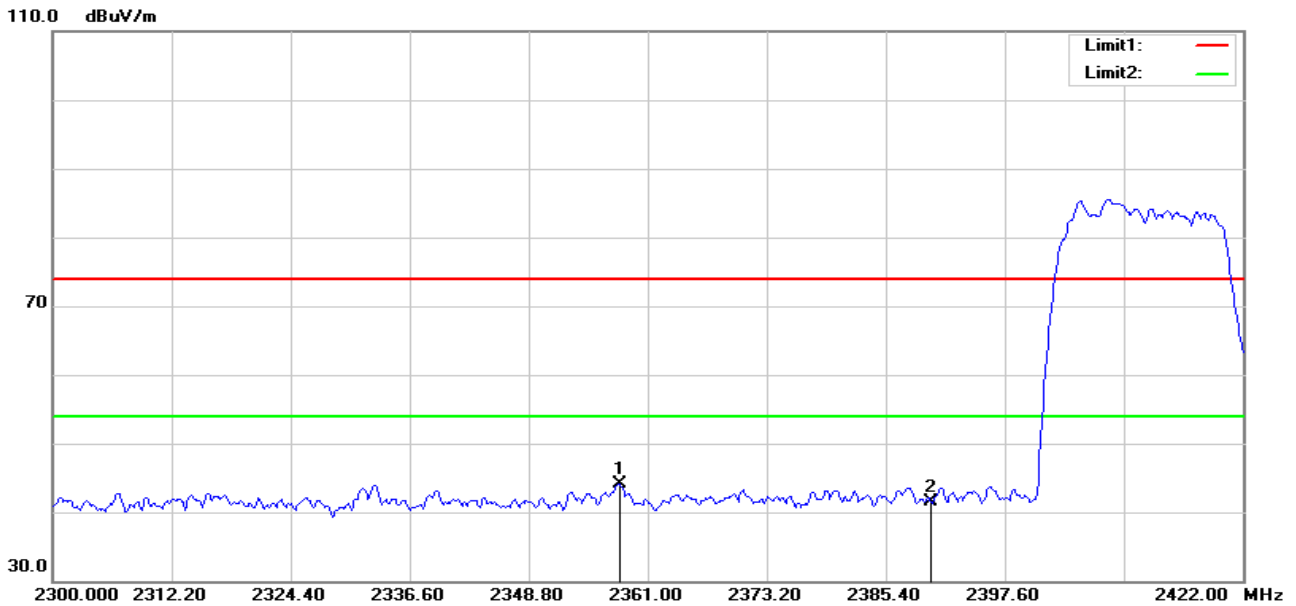

No.	Frequency (MHz)	Reading (dBuV)	Correct Factor(dB/m)	Result (dBuV/m)	Limit (dBuV/m)	Margin (dB)	Remark
1	2358.072	40.20	3.86	44.06	74.00	-29.94	peak
2	2390.000	37.07	4.34	41.41	74.00	-32.59	peak

Vertical

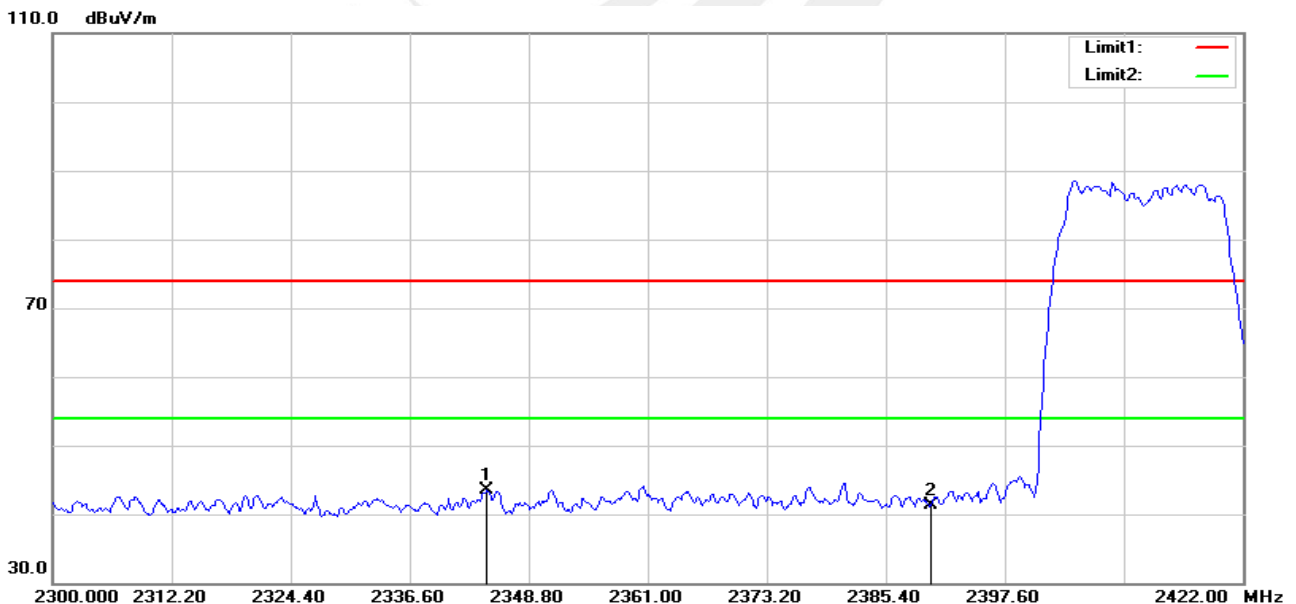

No.	Frequency (MHz)	Reading (dBuV)	Correct Factor(dB/m)	Result (dBuV/m)	Limit (dBuV/m)	Margin (dB)	Remark
1	2344.530	39.73	3.71	43.44	74.00	-30.56	peak
2	2390.000	36.92	4.34	41.26	74.00	-32.74	peak



802.11g-High
Horizontal

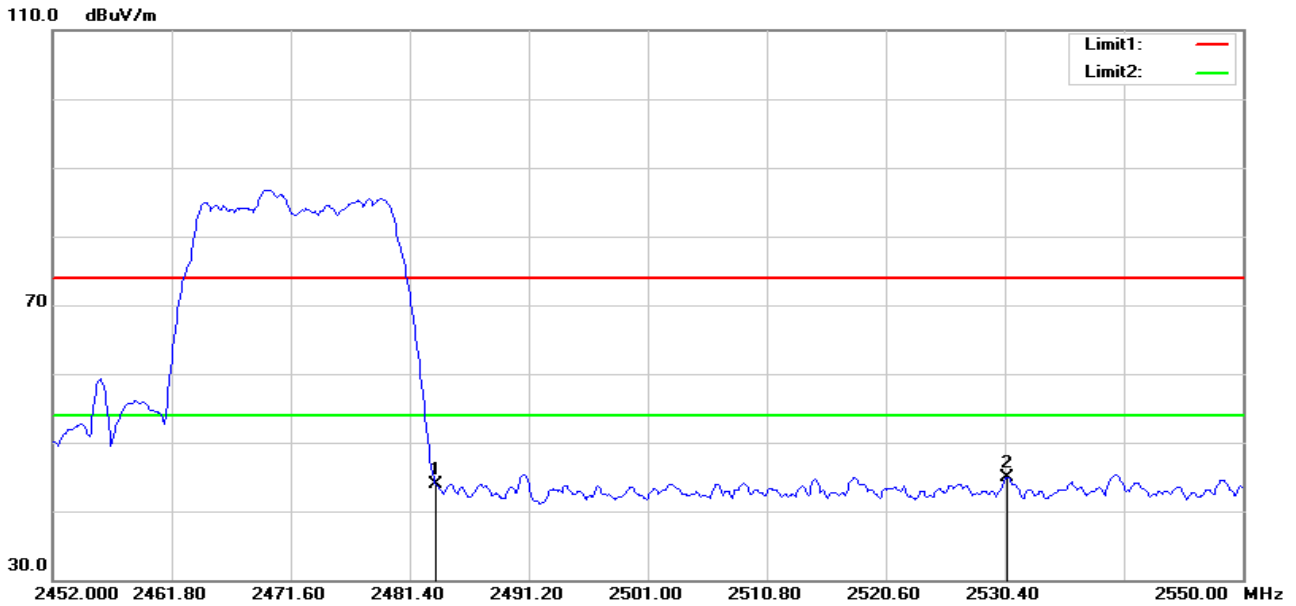

No.	Frequency (MHz)	Reading (dBuV)	Correct Factor(dB/m)	Result (dBuV/m)	Limit (dBuV/m)	Margin (dB)	Remark
1	2483.500	39.36	4.60	43.96	74.00	-30.04	peak
2	2530.596	40.12	4.86	44.98	74.00	-29.02	peak

Vertical

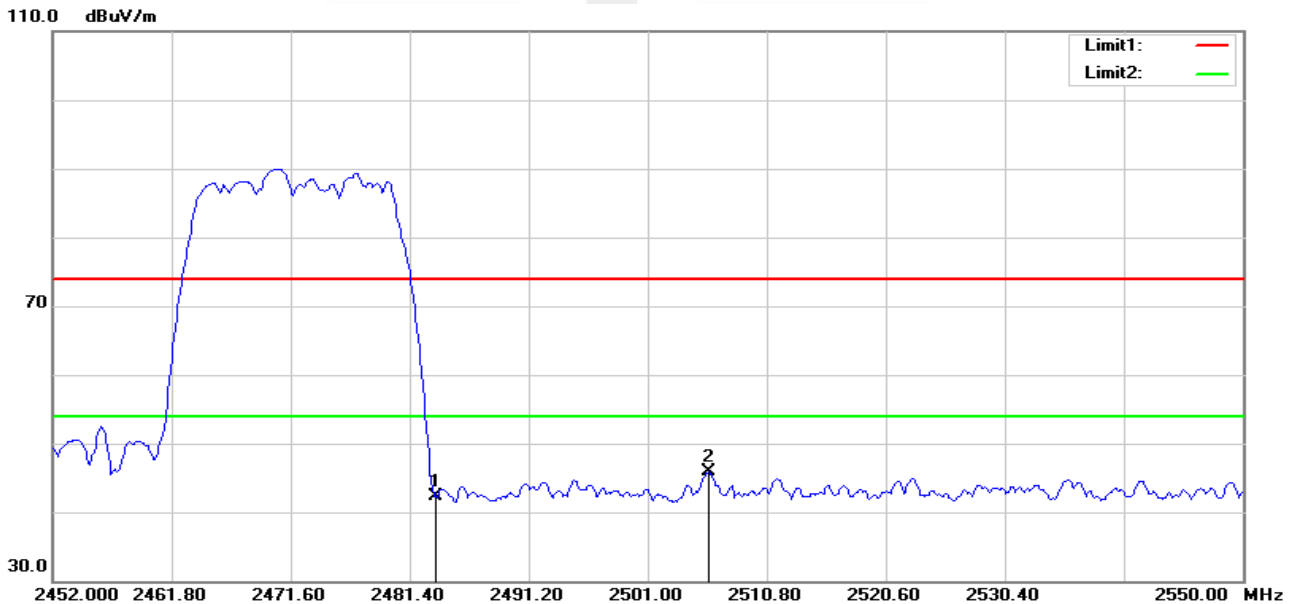

No.	Frequency (MHz)	Reading (dBuV)	Correct Factor(dB/m)	Result (dBuV/m)	Limit (dBuV/m)	Margin (dB)	Remark
1	2483.500	37.61	4.60	42.21	74.00	-31.79	peak
2	2505.998	41.13	4.69	45.82	74.00	-28.18	peak

Note: 802.11b, 802.11g, 802.11n (HT-20), 802.11n (HT-40) mode all have been tested, the worst case is 802.11g, only show the worst case.

4.CONDUCTED SPURIOUS & BAND EDGE EMISSION

4.1 LIMIT

According to FCC section 15.247(d), in any 100kHz bandwidth outside the frequency band in which the spread spectrum or digitally modulated intentional radiator is operating, the radio frequency power that is produced by the intentional radiator shall be at least 20dB below that in the 100kHz bandwidth within the band that contains the highest level of the desired power, based on either an RF conducted or a radiated measurement.

4.2 TEST PROCEDURE

Spectrum Parameter	Setting
Detector	Peak
Start/Stop Frequency	30 MHz to 10th carrier harmonic
RB / VB (emission in restricted band)	100 KHz/300 KHz
Trace-Mode:	Max hold

For Band edge

Spectrum Parameter	Setting
Detector	Peak
Start/Stop Frequency	Lower Band Edge: 2300 to 2412 MHz Upper Band Edge: 2462to 2500 MHz
RB / VB (emission in restricted band)	100 KHz/300 KHz
Trace-Mode:	Max hold

4.3DEVIATION FROM STANDARD

No deviation.

4.4 TEST SETUP

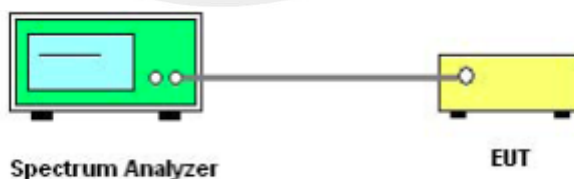

The EUT which is powered by the DC Power, is connected to the Spectrum Analyzer; the RF load attached to the EUT antenna terminal is 50Ohm; the path loss as the factor is calibrated to correct the reading.

Make the measurement with the spectrum analyzer's resolution bandwidth (RBW) = 100 kHz. In order to make an accurate measurement, set the span greater than RBW.

4.5 EUT OPERATION CONDITIONS

The EUT tested system was configured as the statements of 2.3 Unless otherwise a special operating condition is specified in the follows during the testing.



4.6 TEST RESULTS

External Antenna

Temperature:	25°C	Relative Humidity:	60%
Test Voltage:	DC 3.3V	Test Mode:	TX b Mode /CH01, CH06, CH11

CH 01

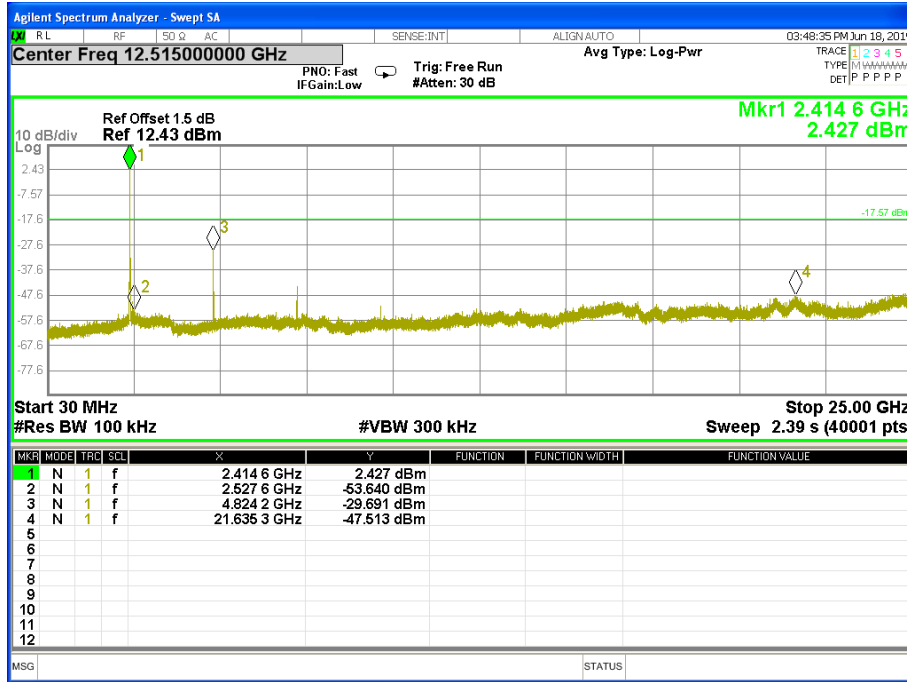

CH 06

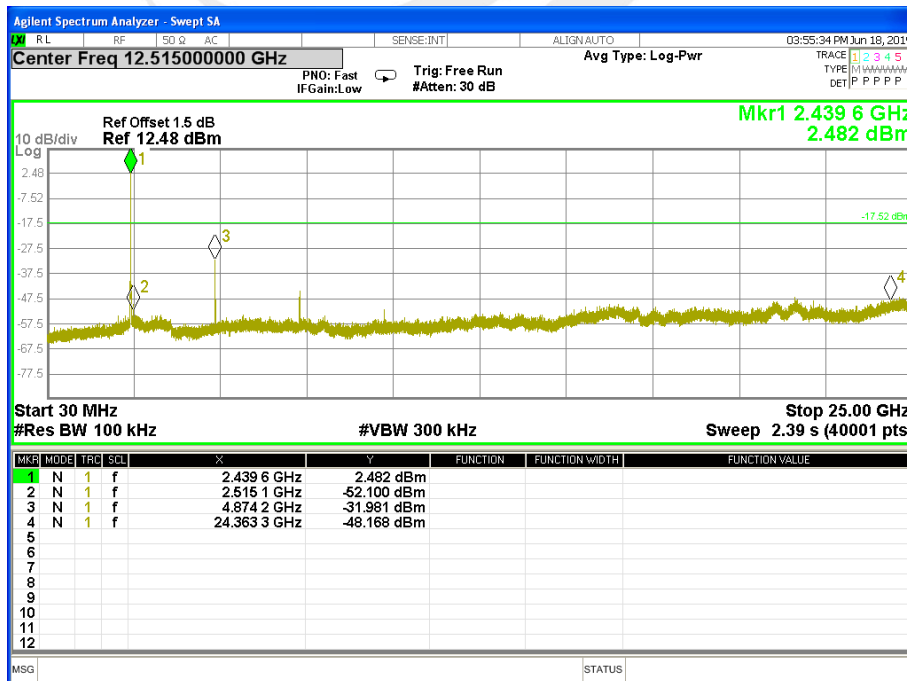



Band edge

CH 01

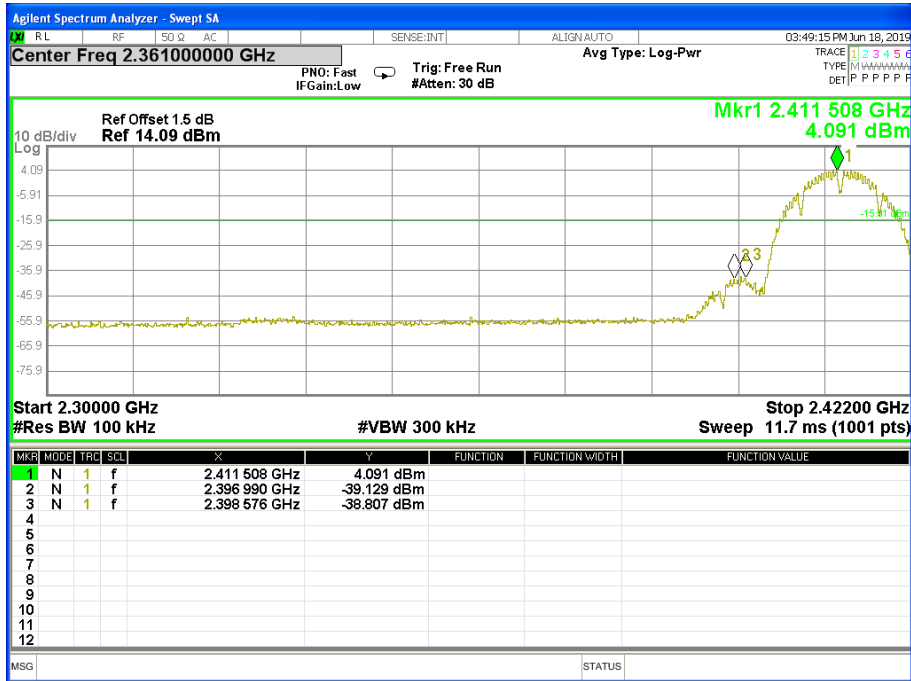

CH 11

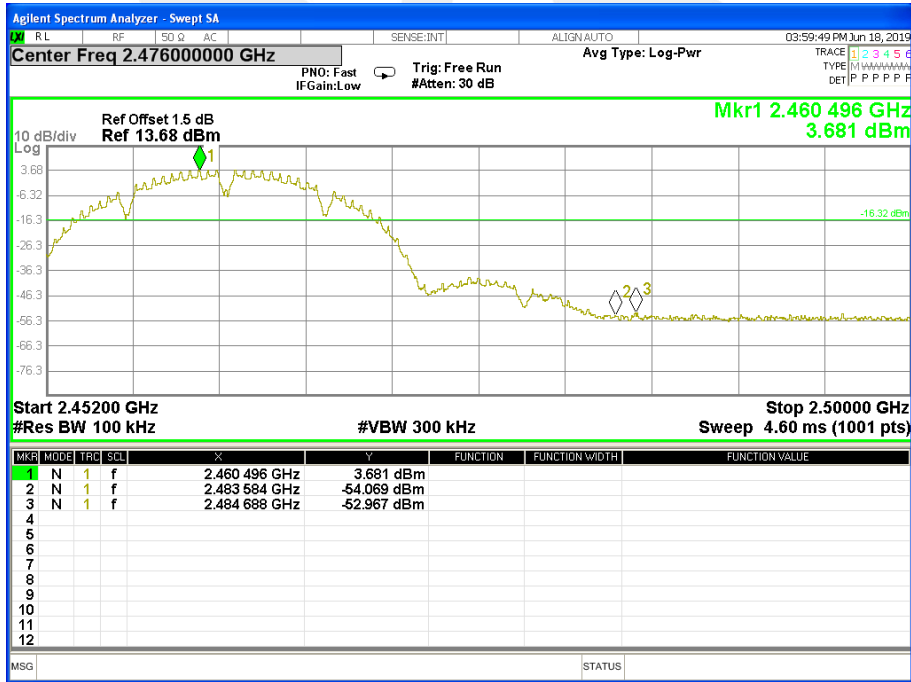



Temperature:	25°C	Relative Humidity:	60%
Test Voltage:	DC 3.3V	Test Mode:	TX g Mode /CH01, CH06, CH11

CH 01

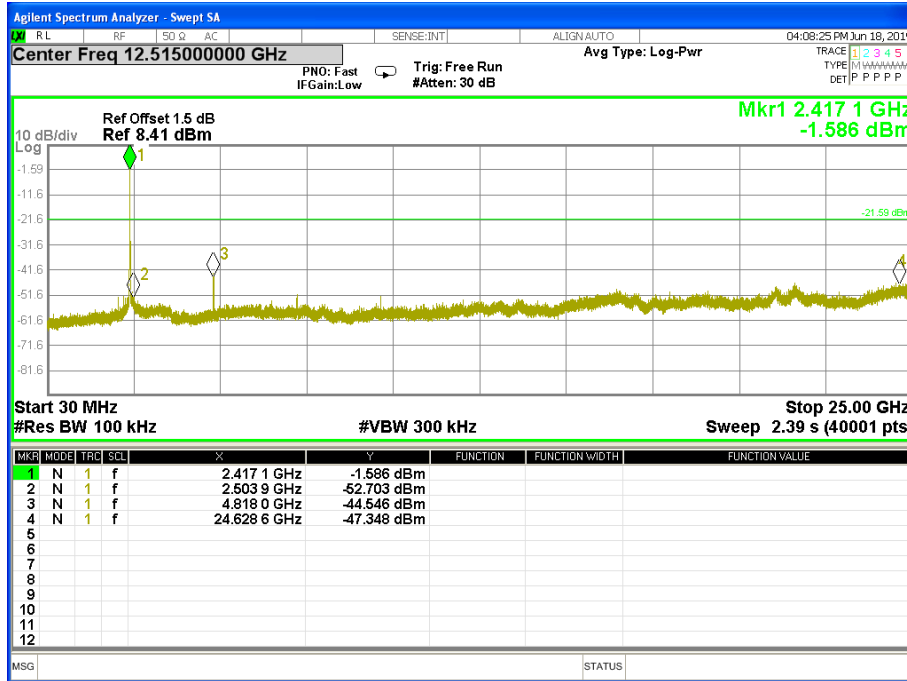

CH06

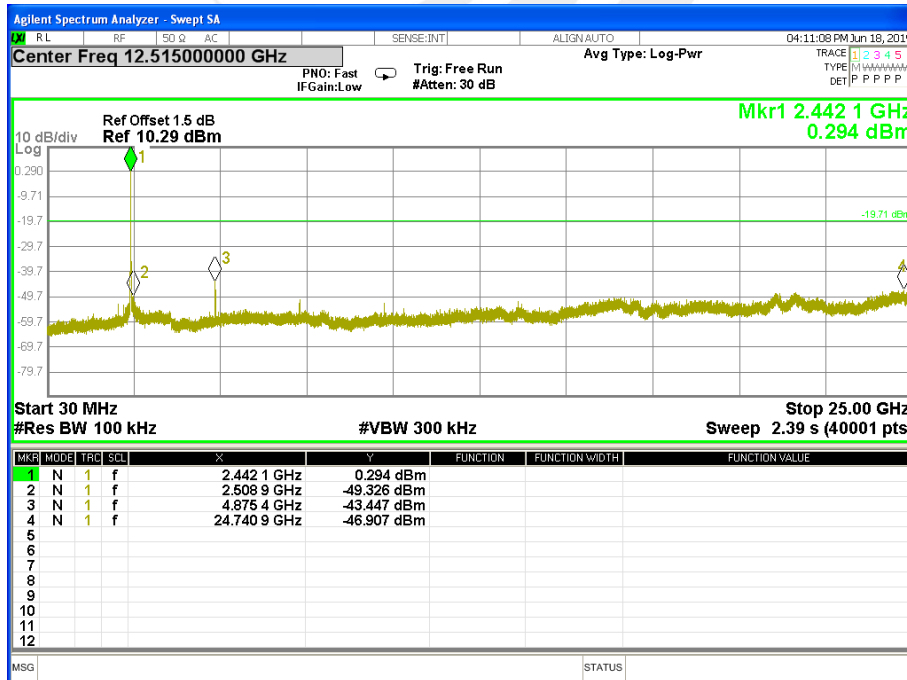



CH 11

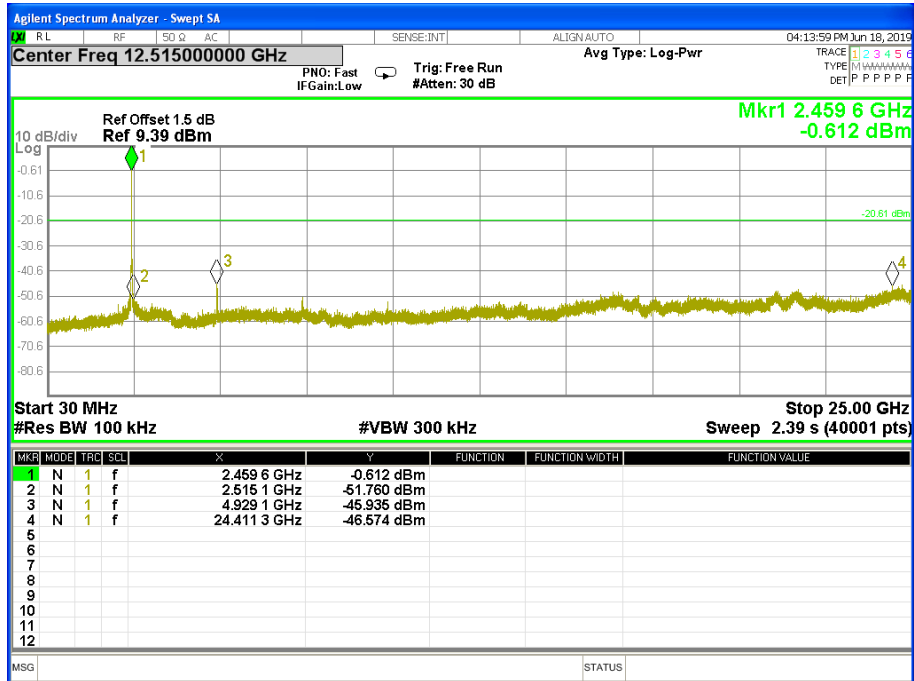



Band edge

CH 01

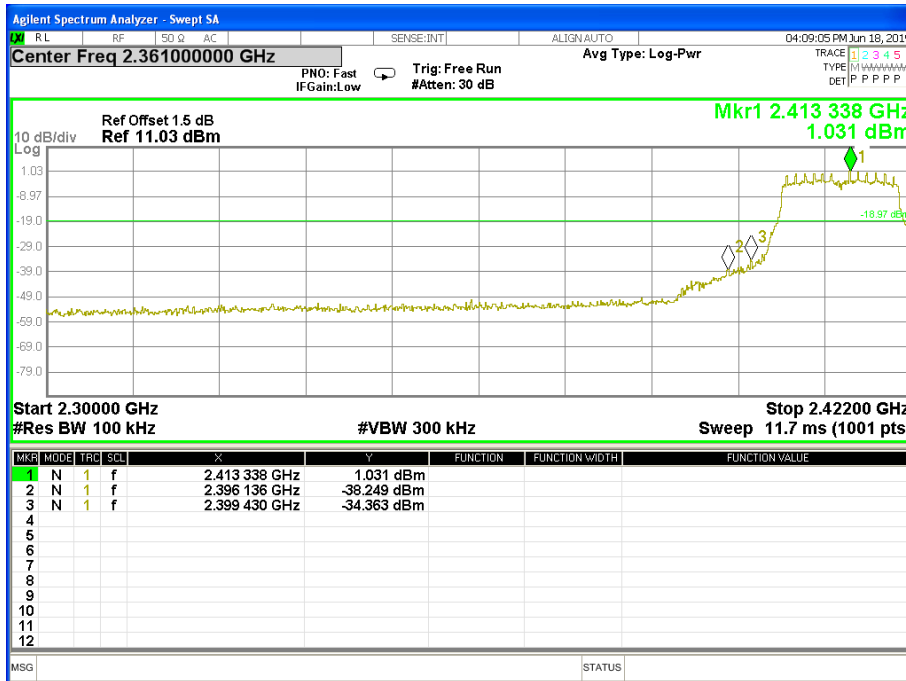

CH11

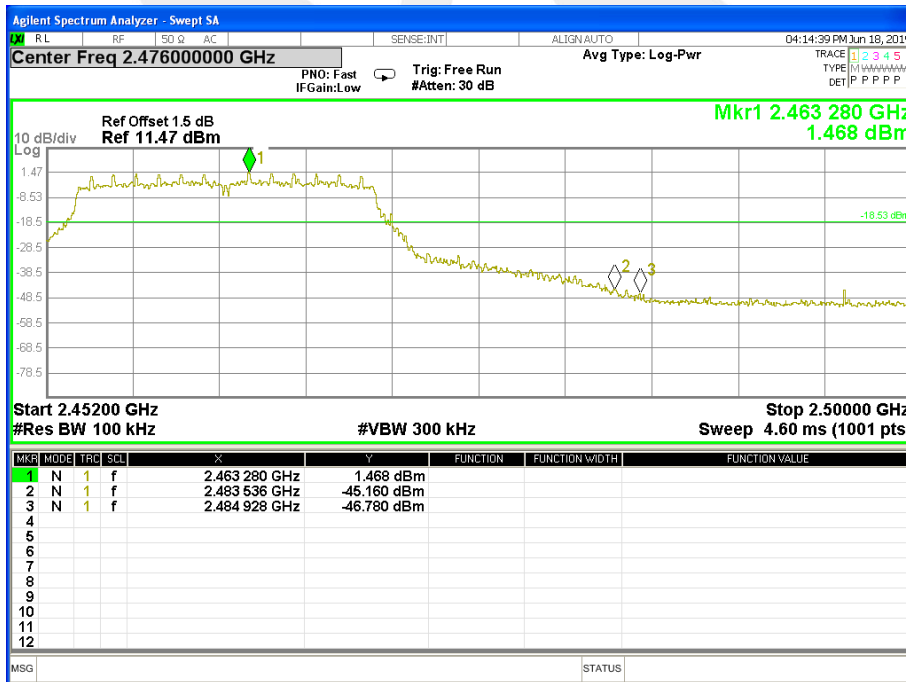



Temperature:	25°C	Relative Humidity:	60%
Test Voltage:	DC 3.3V	Test Mode:	TX n Mode(20M) /CH01, CH06, CH11

CH 01

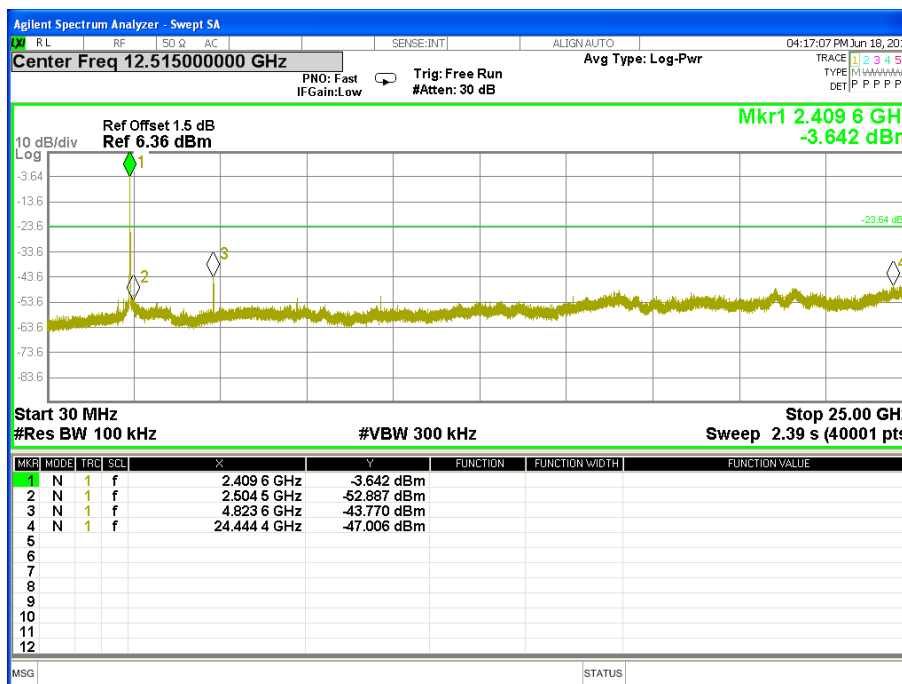

CH 06

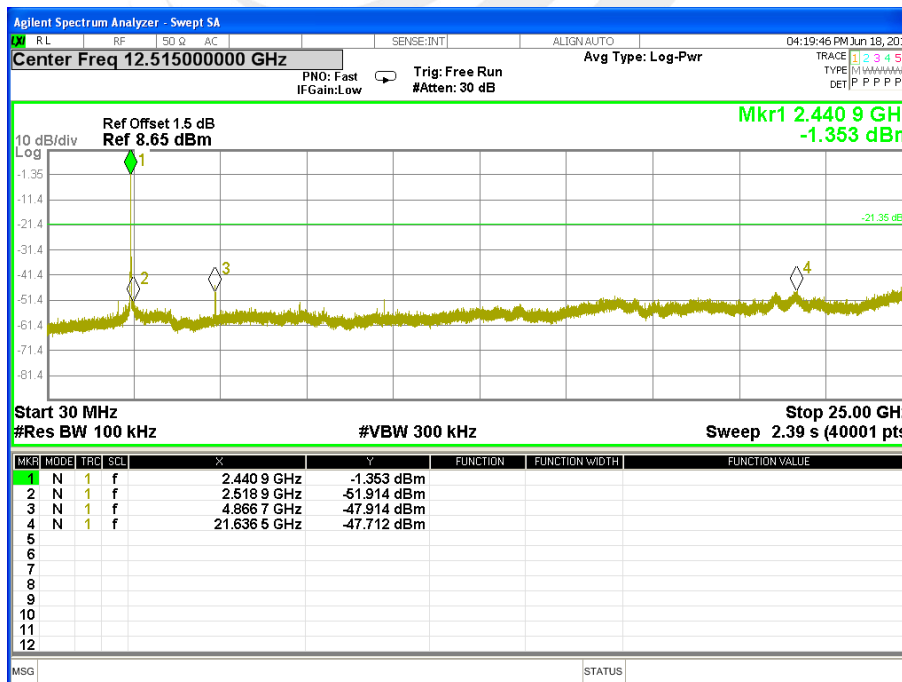



CH 11

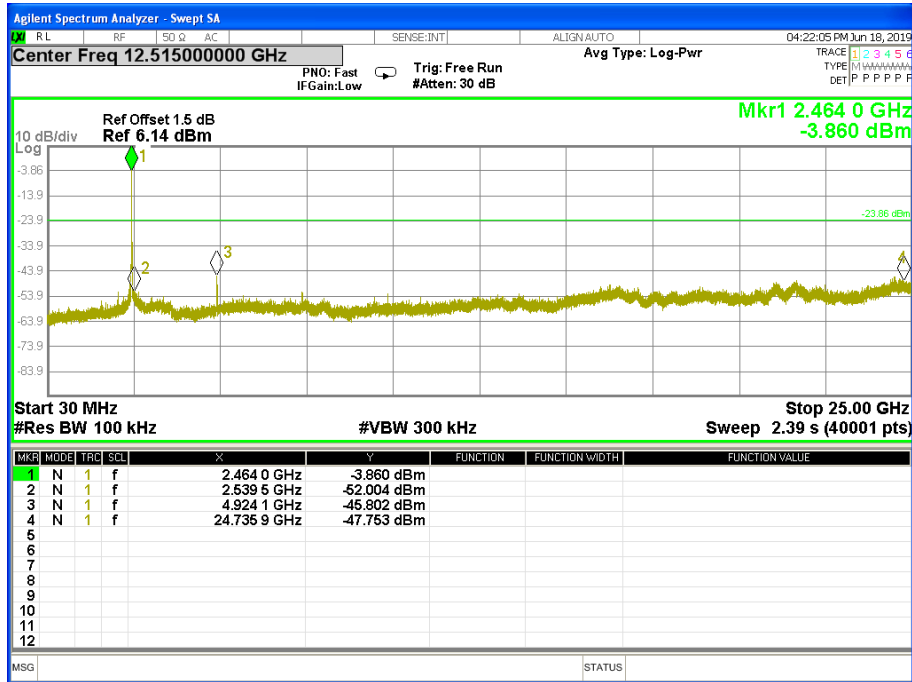



Band edge

CH 01

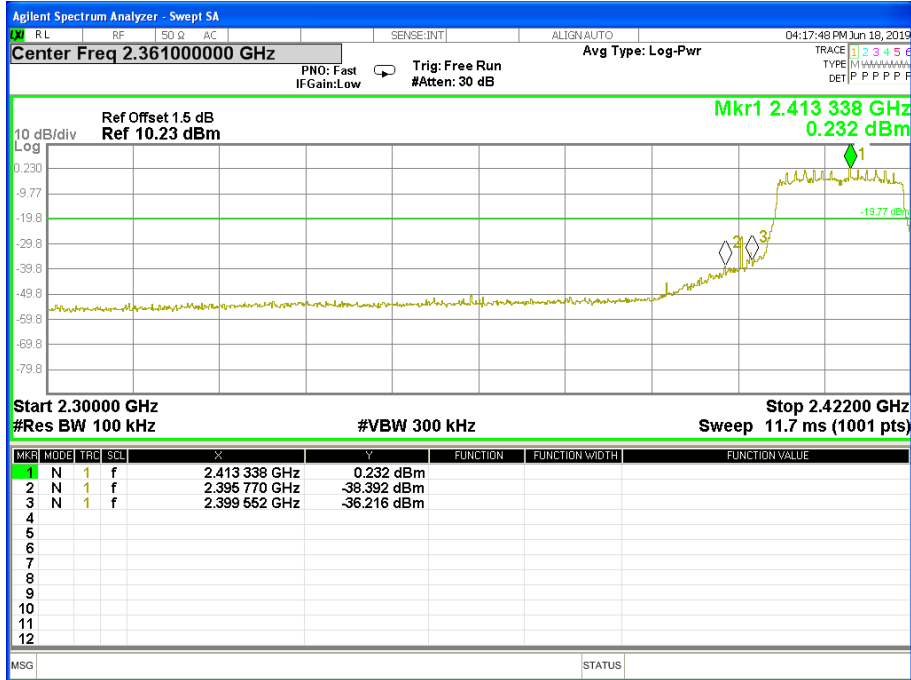

CH 11

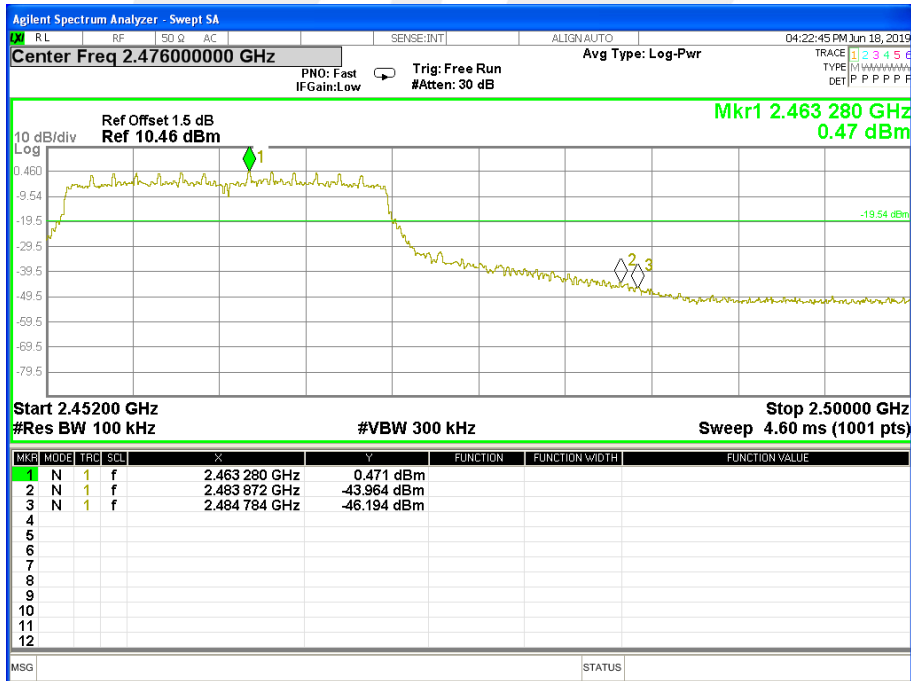



Temperature:	25°C	Relative Humidity:	60%
Test Voltage:	DC 3.3V	Test Mode:	TX n Mode(40M) /CH03, CH06, CH09

CH 03

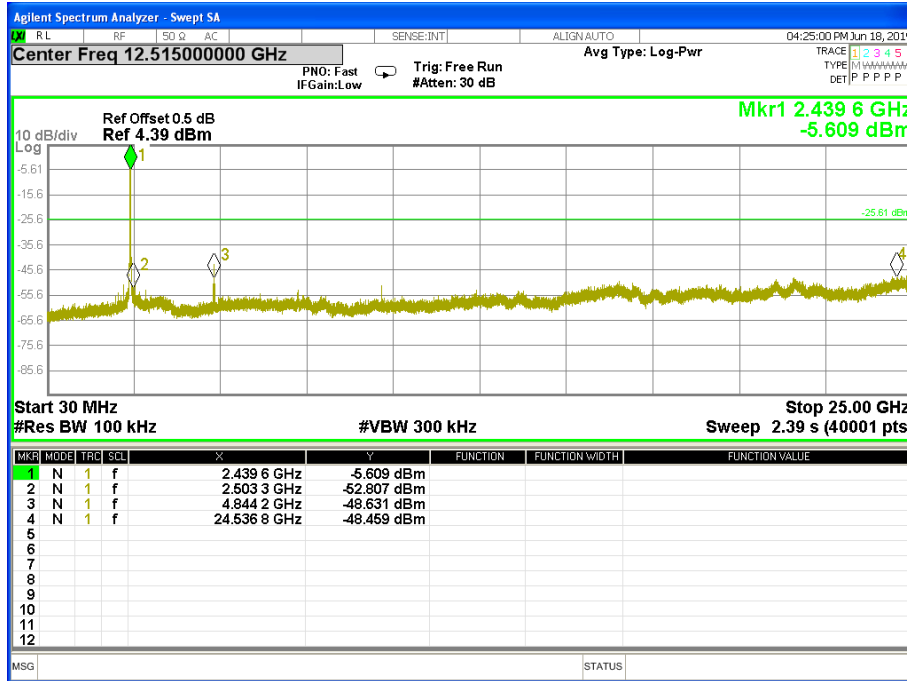

CH06

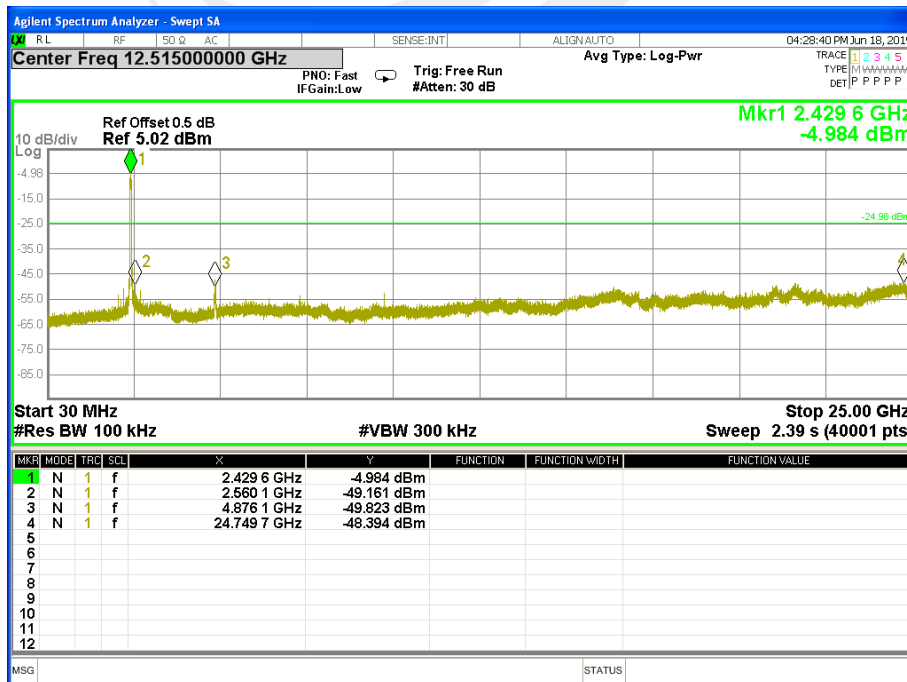



Band edge

CH03

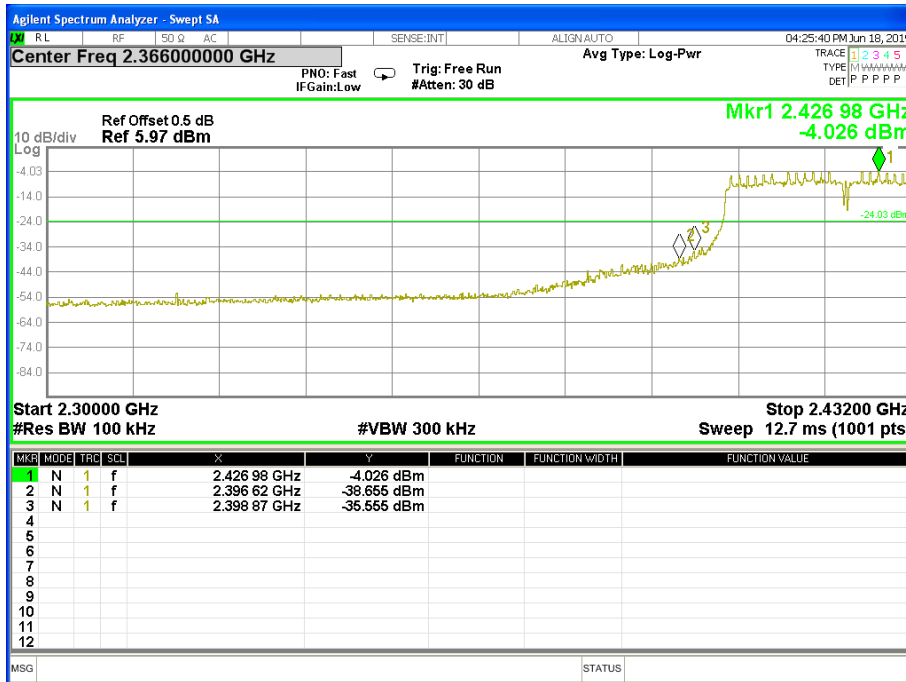

CH 09

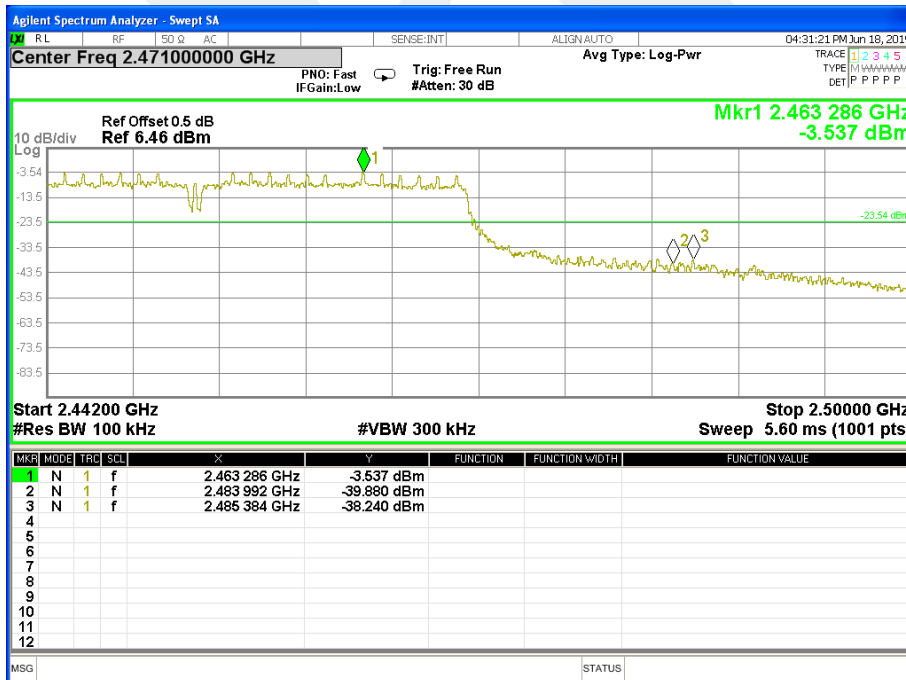



PCB Antenna

Temperature:	25°C	Relative Humidity:	60%
Test Voltage:	DC 3.3V	Test Mode:	TX b Mode /CH01, CH06, CH11

CH 01

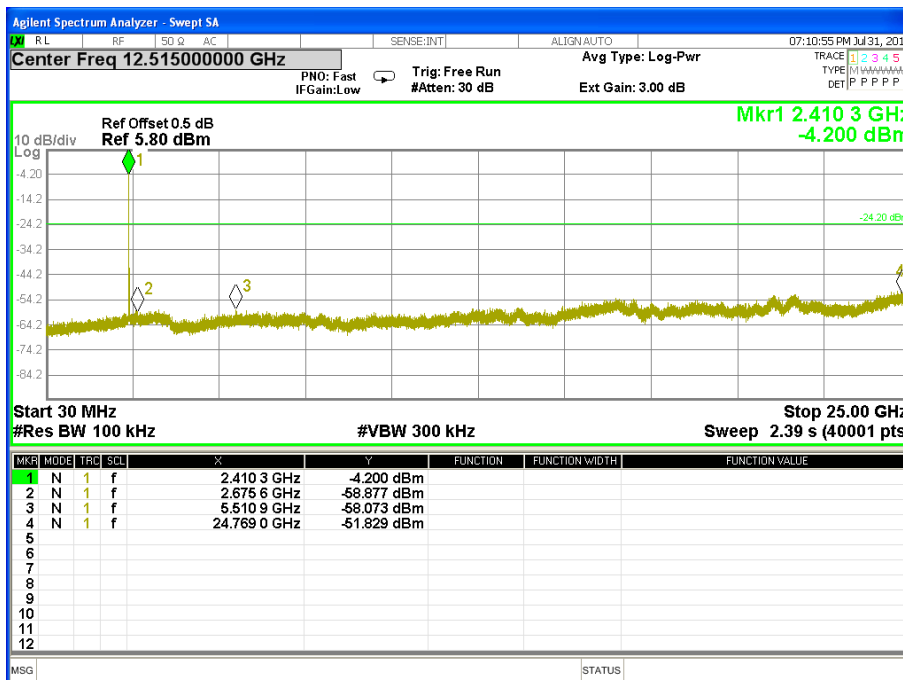

CH 06

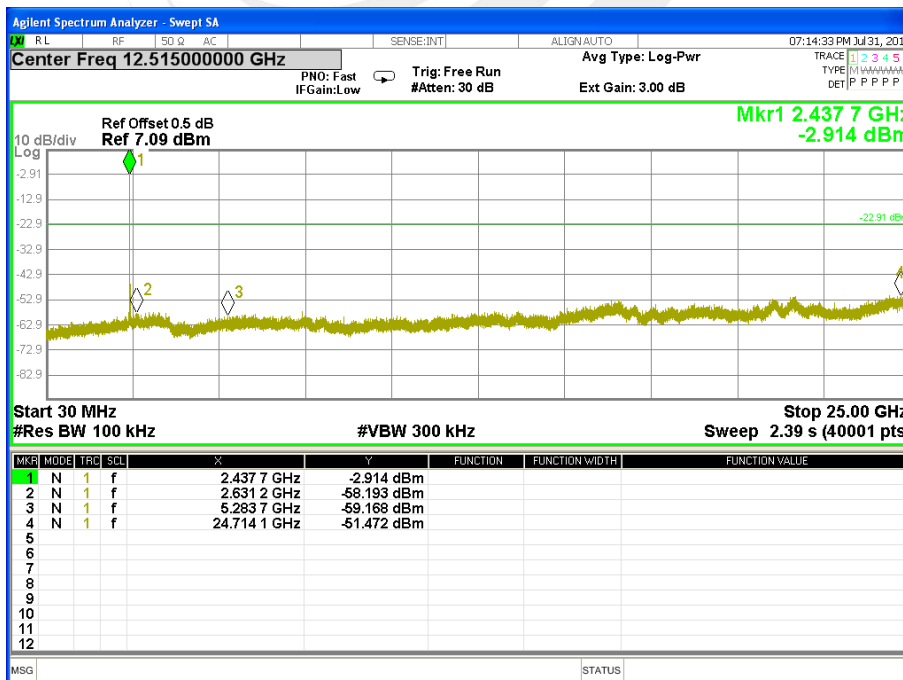



CH 11

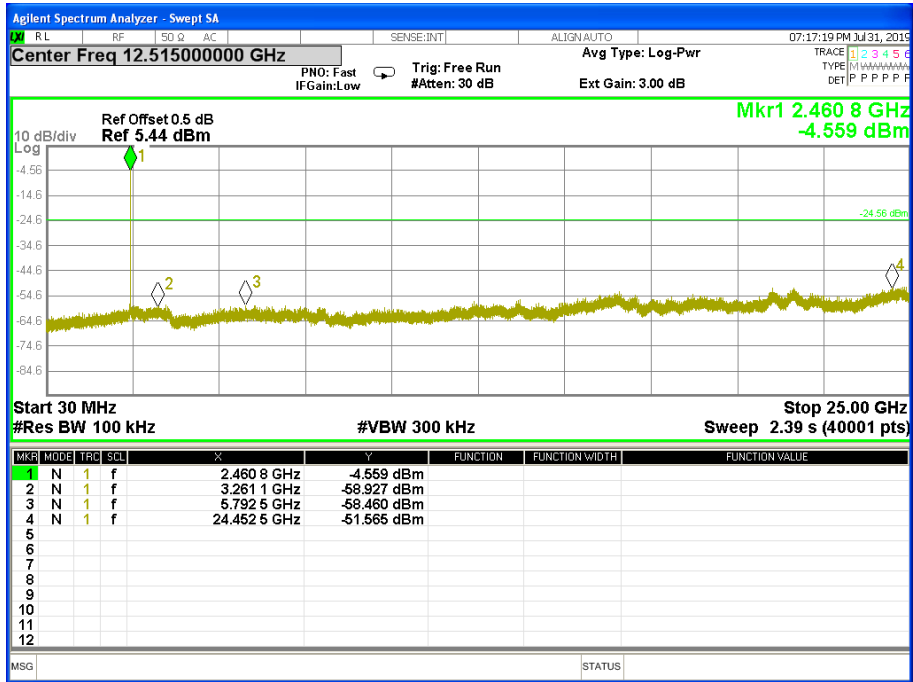



Band edge

CH 01

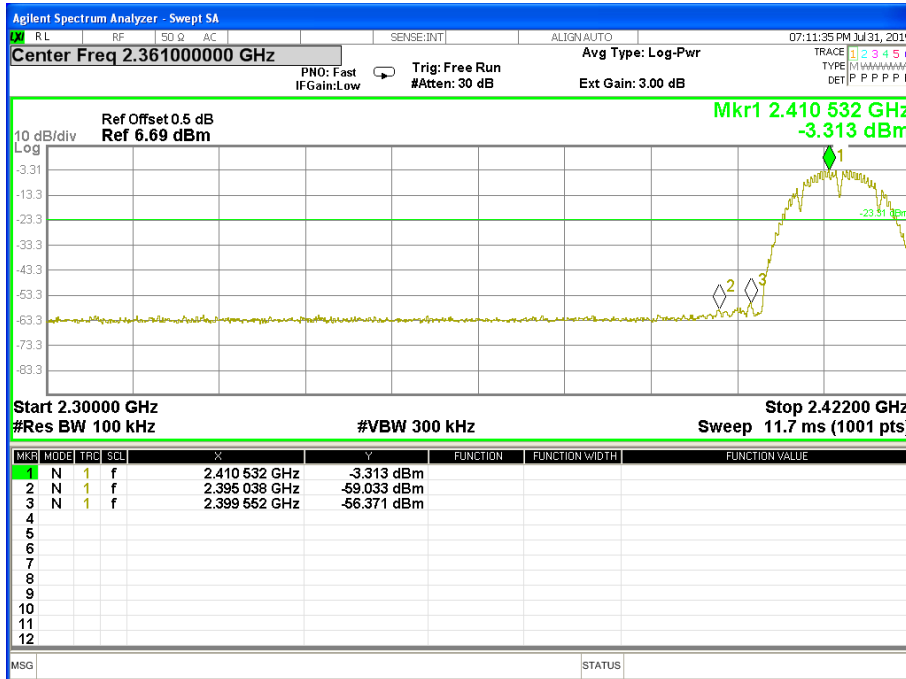

CH 11

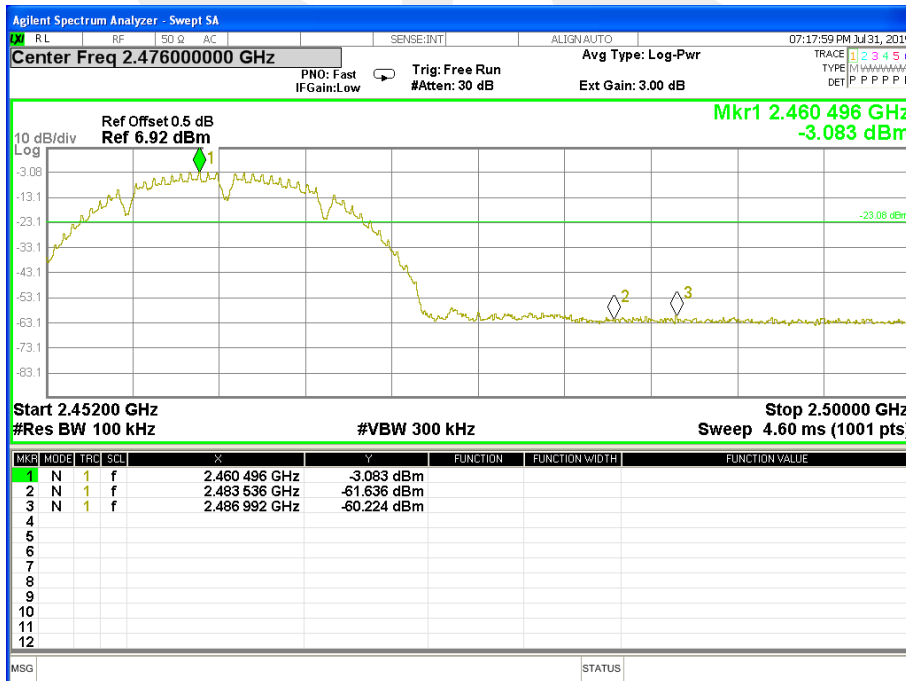



Temperature:	25°C	Relative Humidity:	60%
Test Voltage:	DC 3.3V	Test Mode:	TX g Mode /CH01, CH06, CH11

CH 01

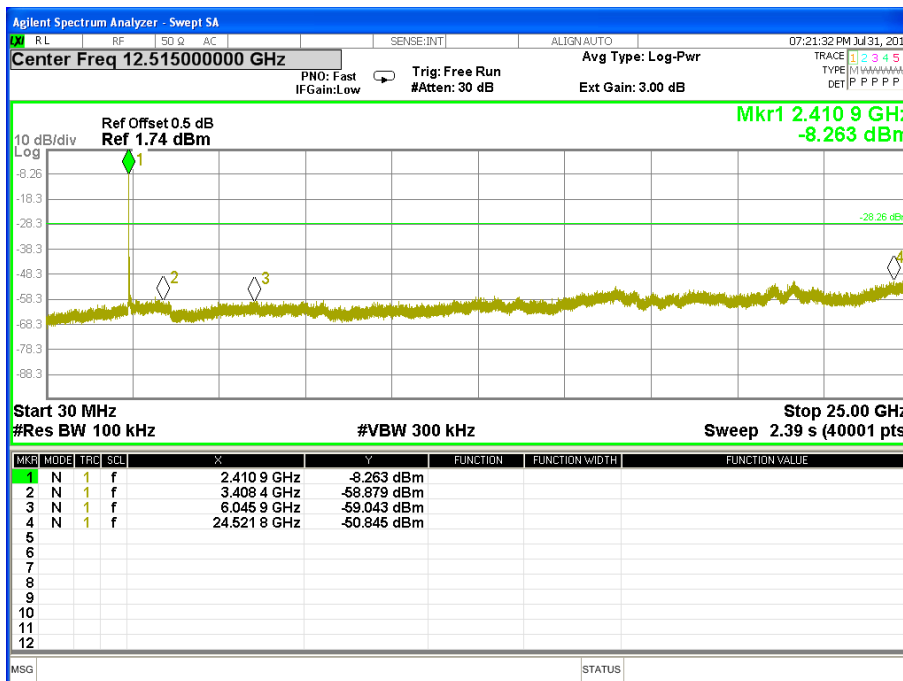

CH06

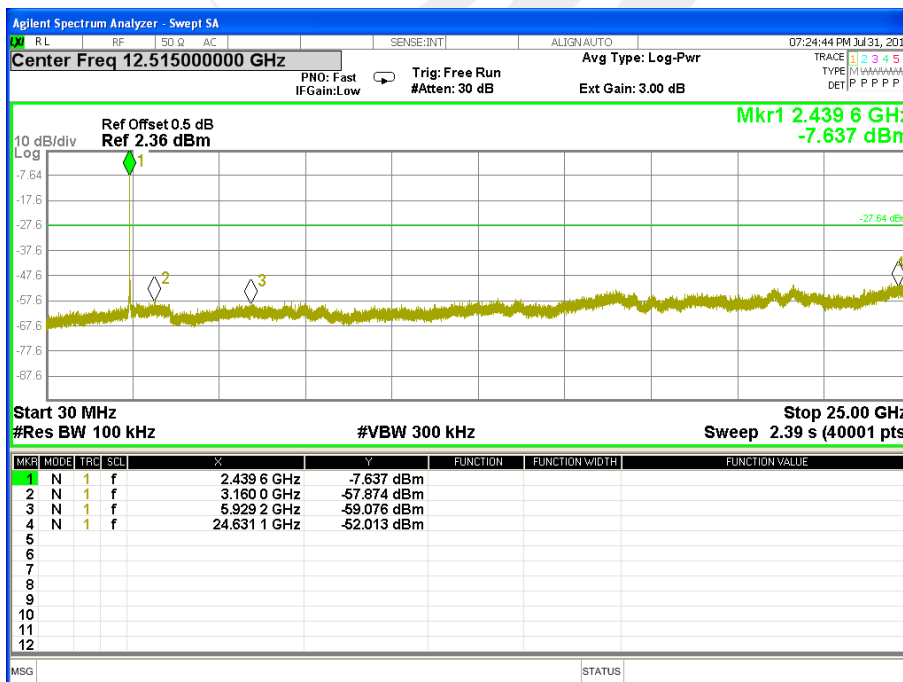



CH 11

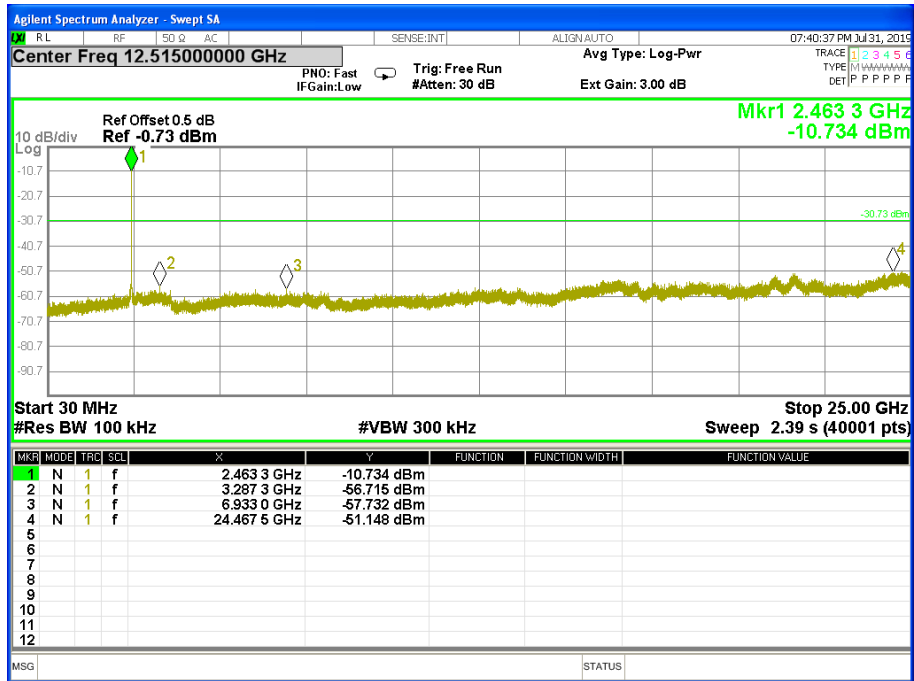



Band edge

CH 01

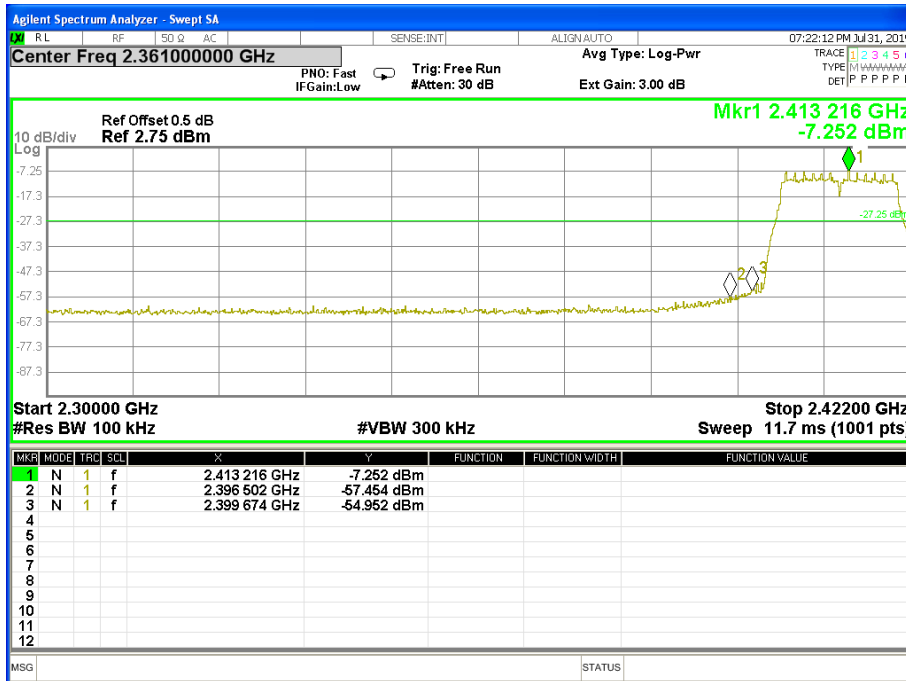

CH11

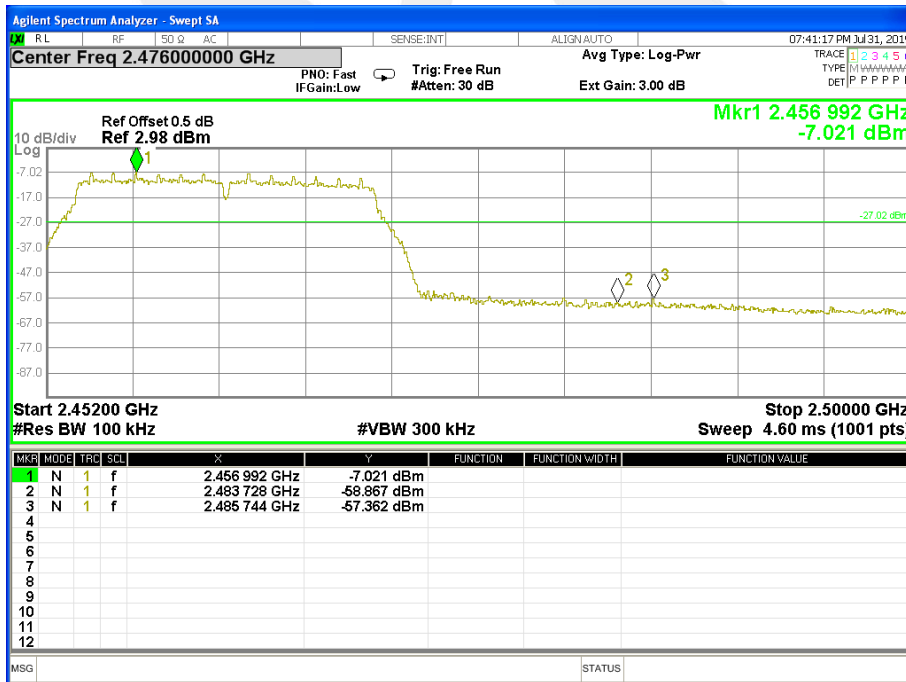



Temperature:	25°C	Relative Humidity:	60%
Test Voltage:	DC 3.3V	Test Mode:	TX n Mode(20M) /CH01, CH06, CH11

CH 01

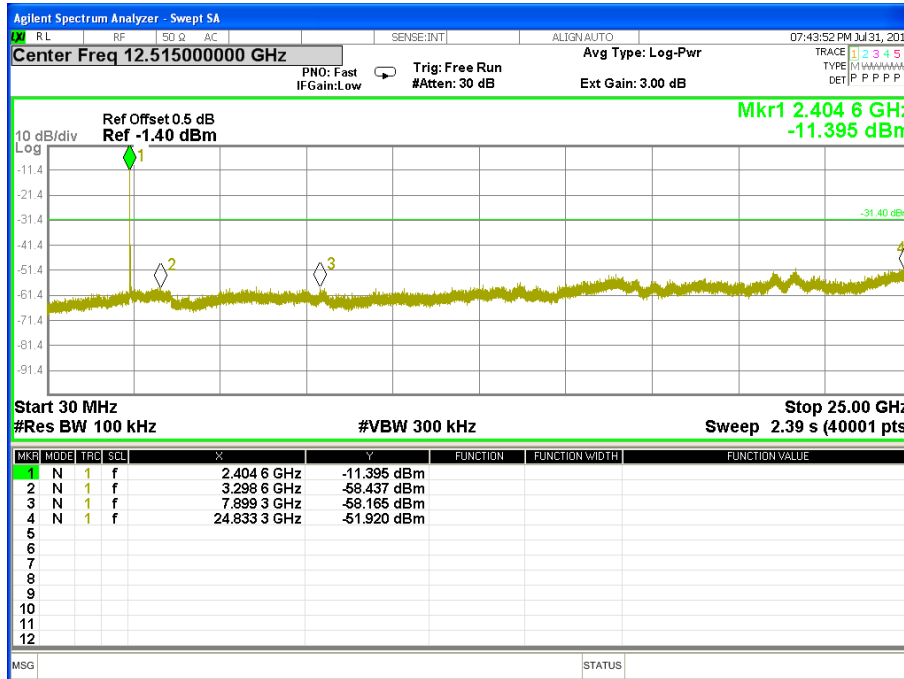

CH 06

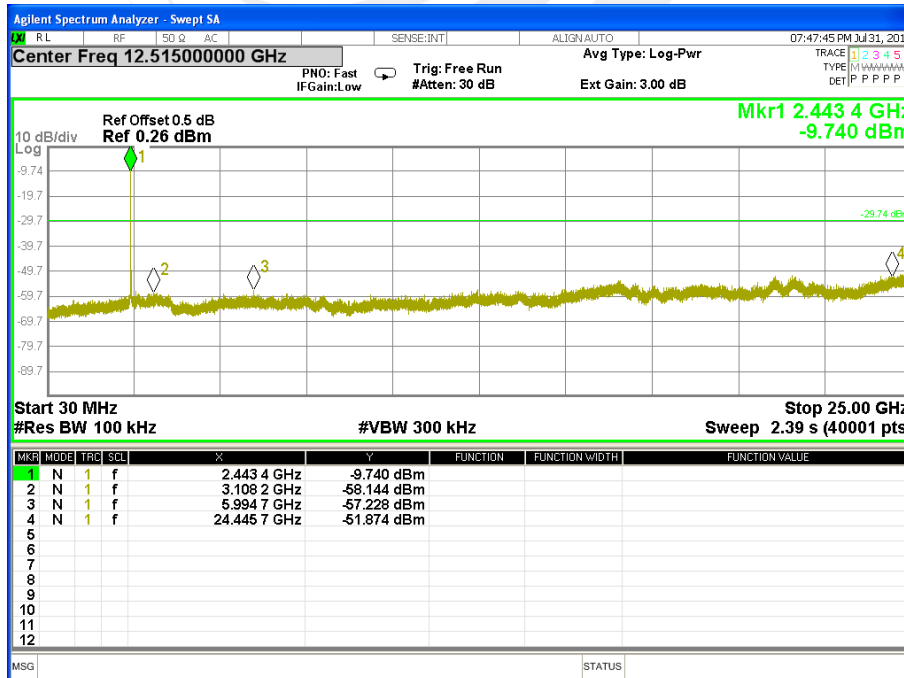



CH 11

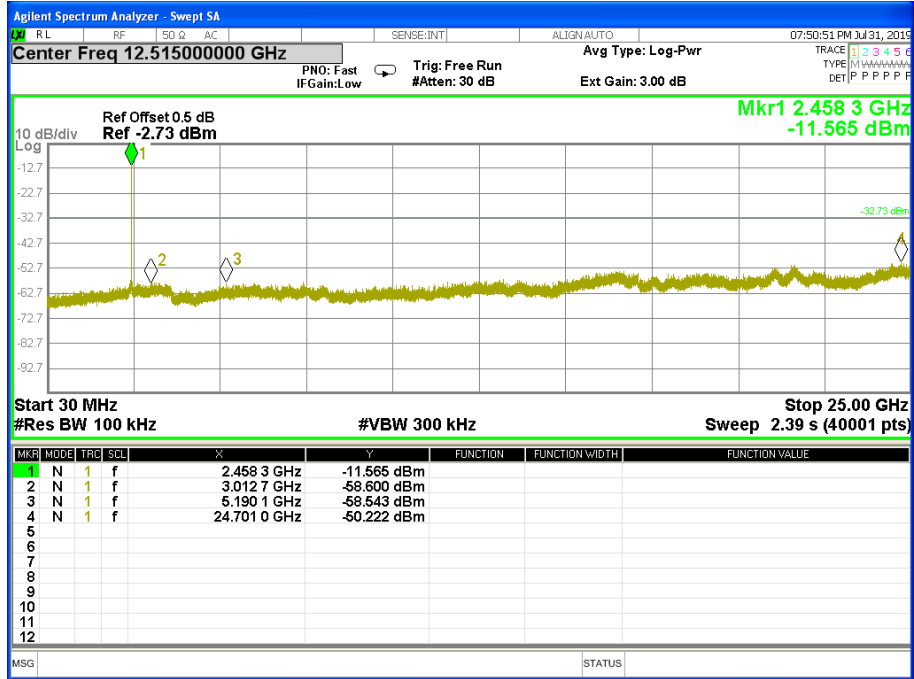



Band edge

CH 01

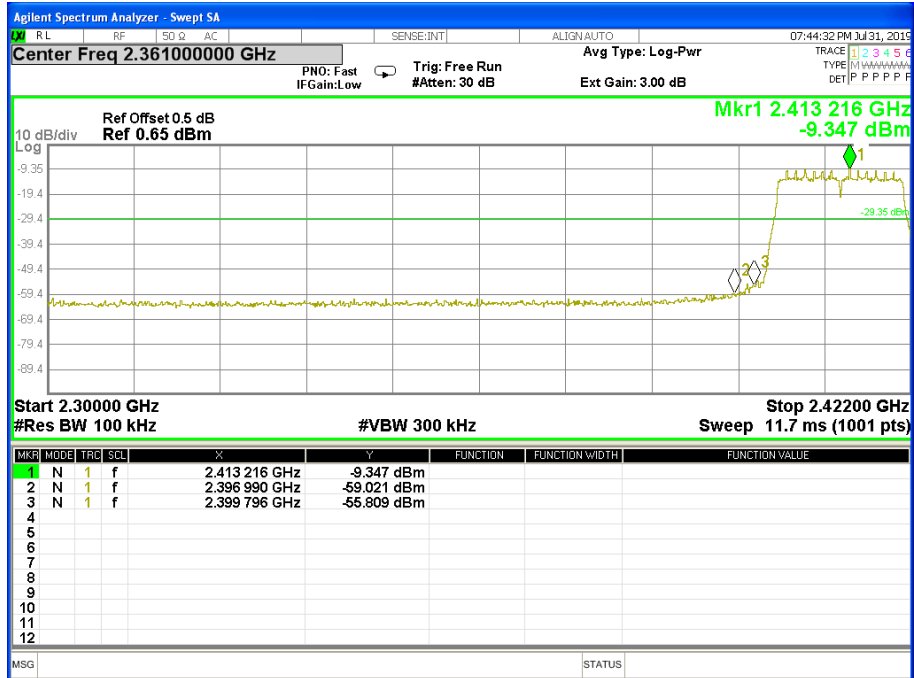

CH 11

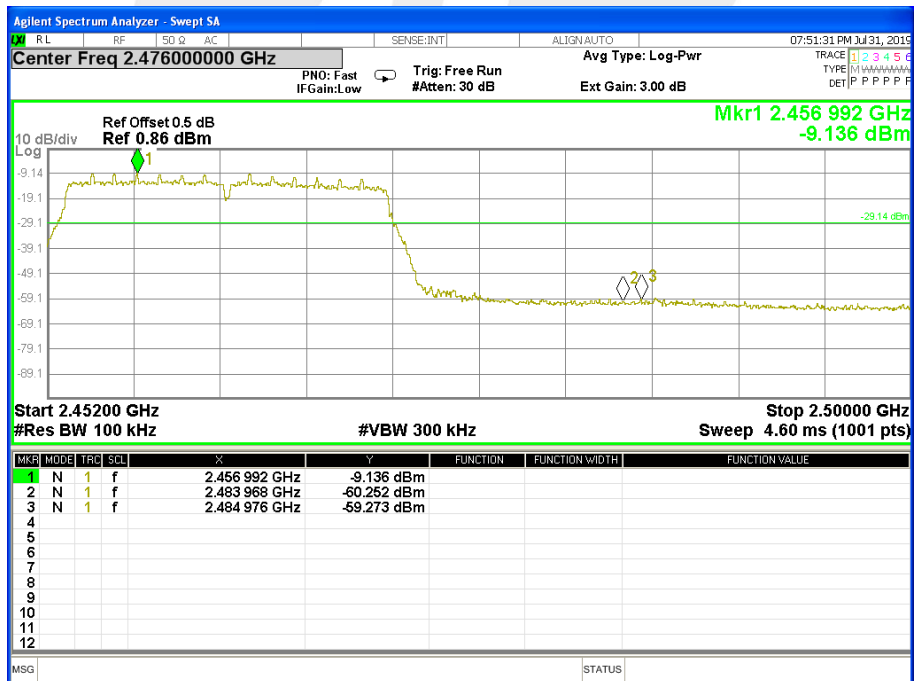



Temperature:	25°C	Relative Humidity:	60%
Test Voltage:	DC 3.3V	Test Mode:	TX n Mode(40M) /CH03, CH06, CH09

CH 03

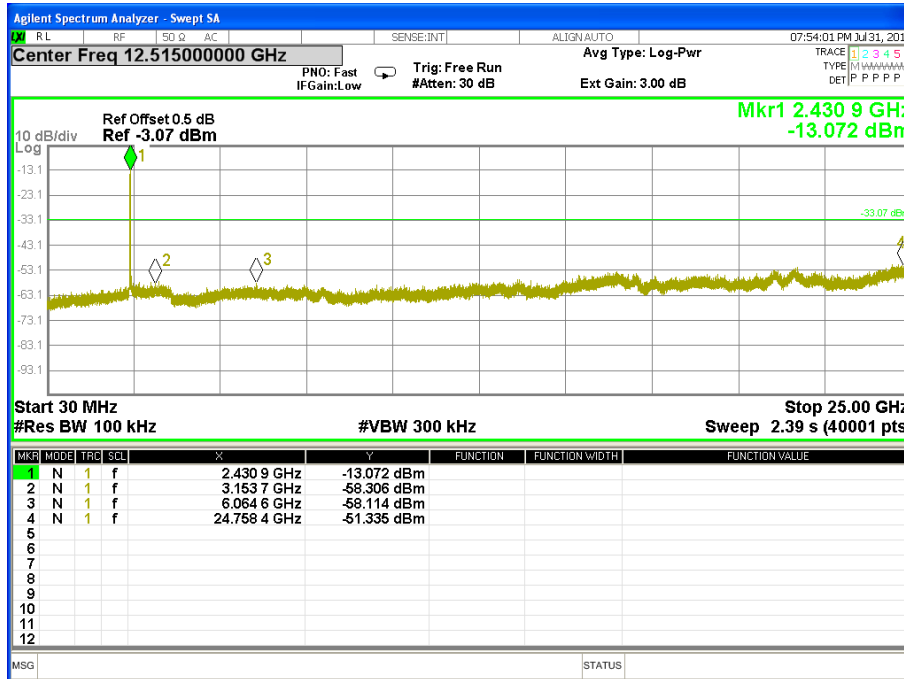

CH06

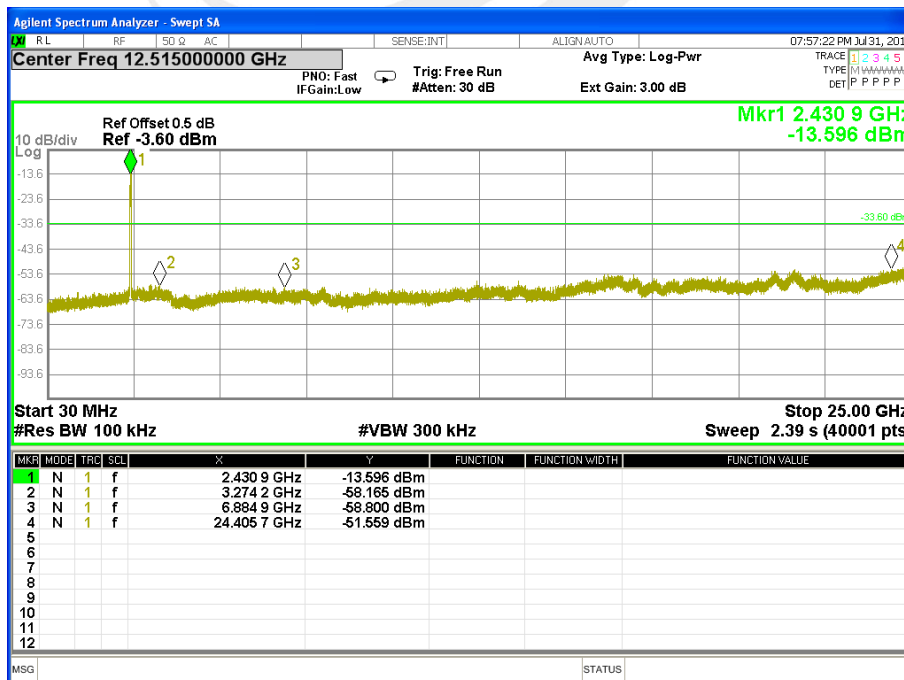



CH09

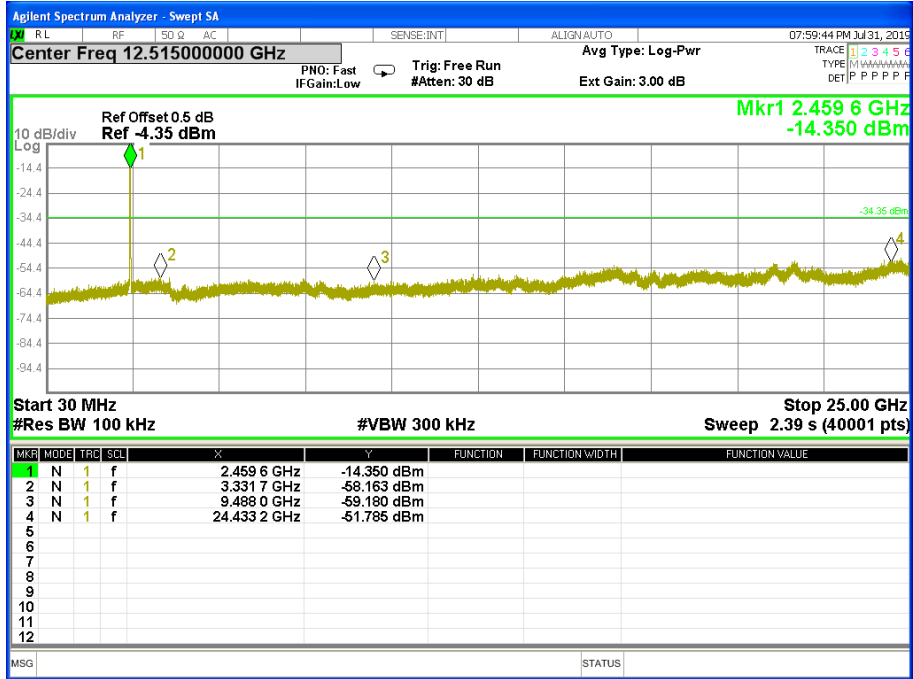



Band edge

CH03

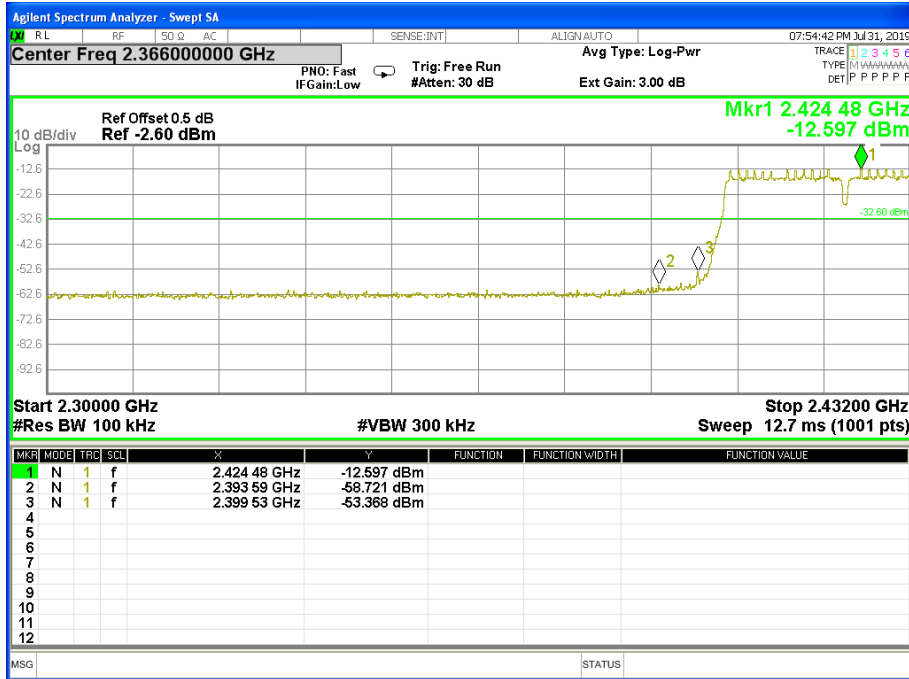

CH 09

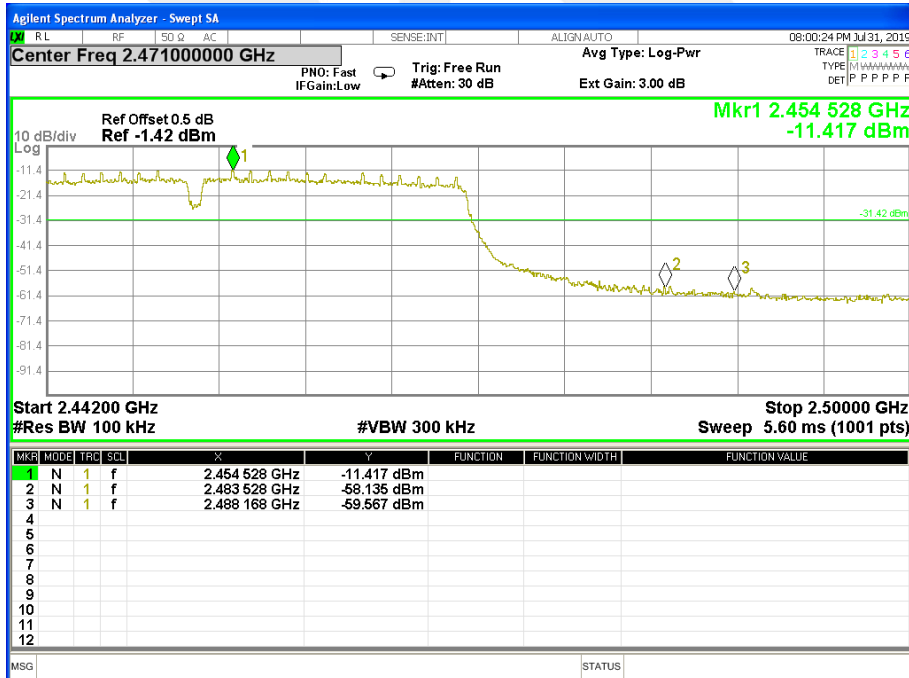



5. POWER SPECTRAL DENSITY TEST

5.1 LIMIT

FCC Part15.247 , Subpart C				
Section	Test Item	Limit	Frequency Range (MHz)	Result
15.247(e)	Power Spectral Density	≤ 8 dBm (RBW ≥ 3 KHz)	2400-2483.5	PASS

5.2 TEST PROCEDURE

1. Set analyzer center frequency to DTS channel center frequency.
2. Set the span to 1.5 times the DTS channel bandwidth.
3. Set the $100 \text{ kHz} \geq \text{RBW} \geq 3 \text{ kHz}$.
4. Set the $\text{VBW} \geq 3 \times \text{RBW}$.
5. Detector = peak.
6. Sweep time = auto couple.
7. Trace mode = max hold.
8. Allow trace to fully stabilize.
9. Use the peak marker function to determine the maximum amplitude level.
10. If measured value exceeds limit, reduce RBW (no less than 3 kHz) and repeat.

5.3 DEVIATION FROM STANDARD

No deviation.

5.4 TEST SETUP



5.5 EUT OPERATION CONDITIONS

The EUT tested system was configured as the statements of 2.3 Unless otherwise a special operating condition is specified in the follows during the testing.



5.6 TEST RESULTS

External Antenna

Temperature:	25°C	Relative Humidity:	60%
Test Voltage:	DC 3.3V	Test Mode:	TX b Mode /CH01, CH06, CH11

Frequency	Power Density	Limit (dBm/3KHz)	Result
	(dBm/3kHz)		
2412 MHz	-10.668	≤8	PASS
2437 MHz	-10.261	≤8	PASS
2462 MHz	-10.555	≤8	PASS

TX CH01





TX CH06

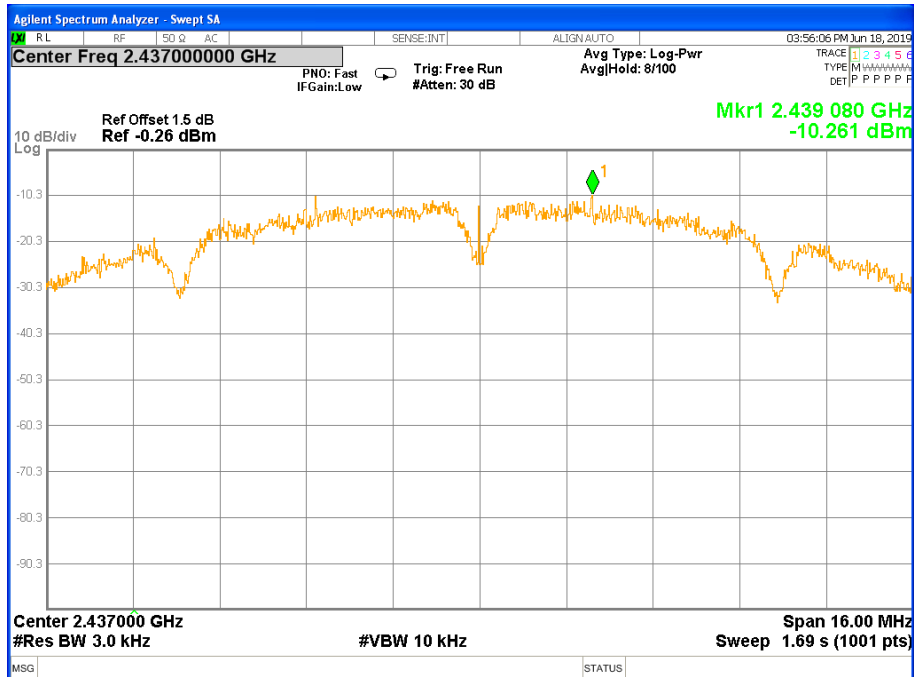

TX CH11

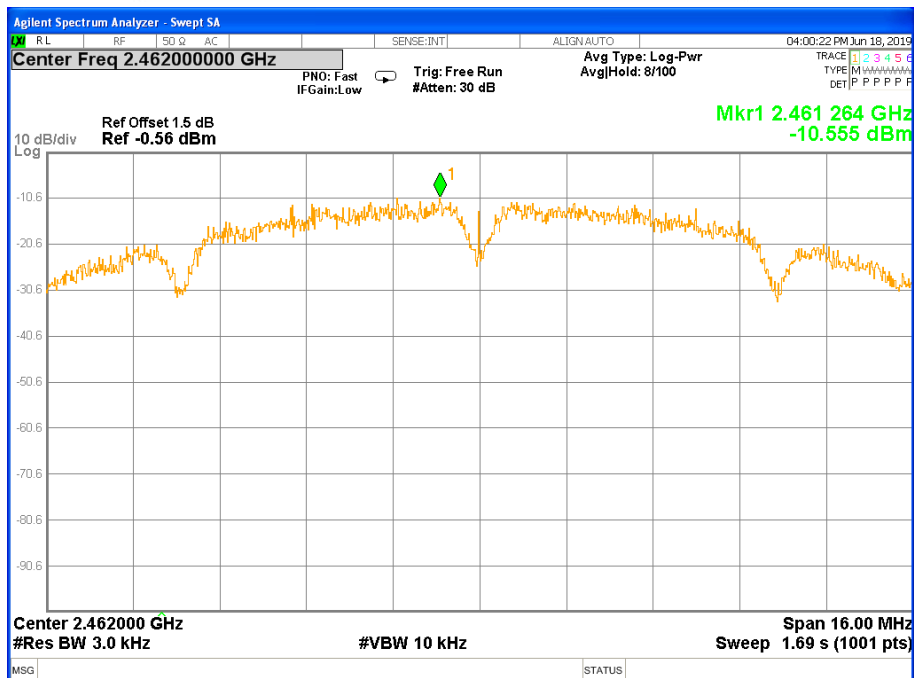



Temperature:	25°C	Relative Humidity:	60%
Test Voltage:	DC 3.3V	Test Mode:	TX g Mode /CH01, CH06, CH11

Frequency	Power Density	Limit (dBm/3KHz)	Result
	(dBm/3kHz)		
2412 MHz	-7.988	≤8	PASS
2437 MHz	-7.578	≤8	PASS
2462 MHz	-8.049	≤8	PASS

TX CH01

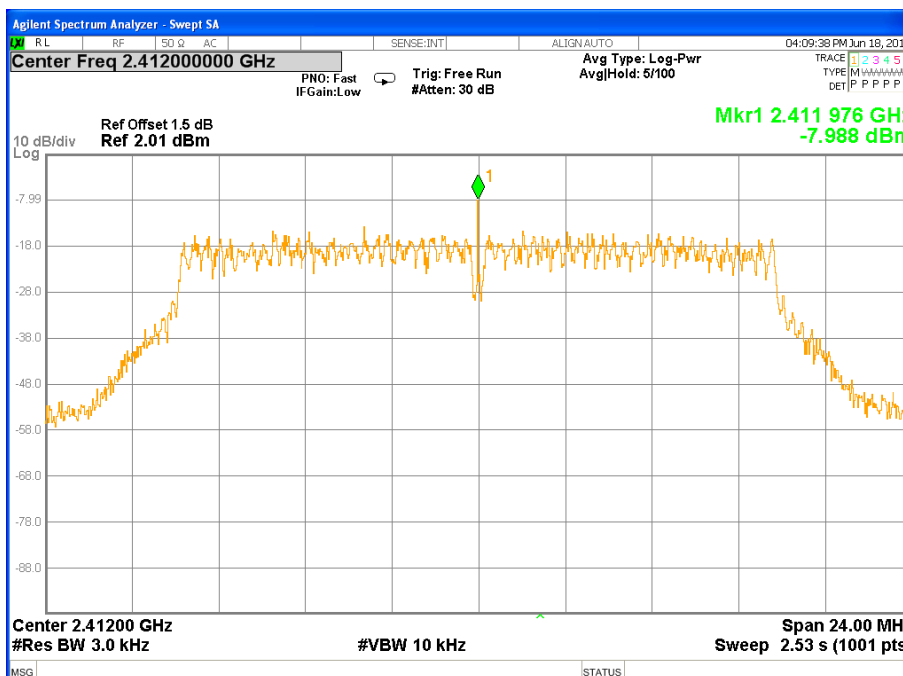



TX CH06

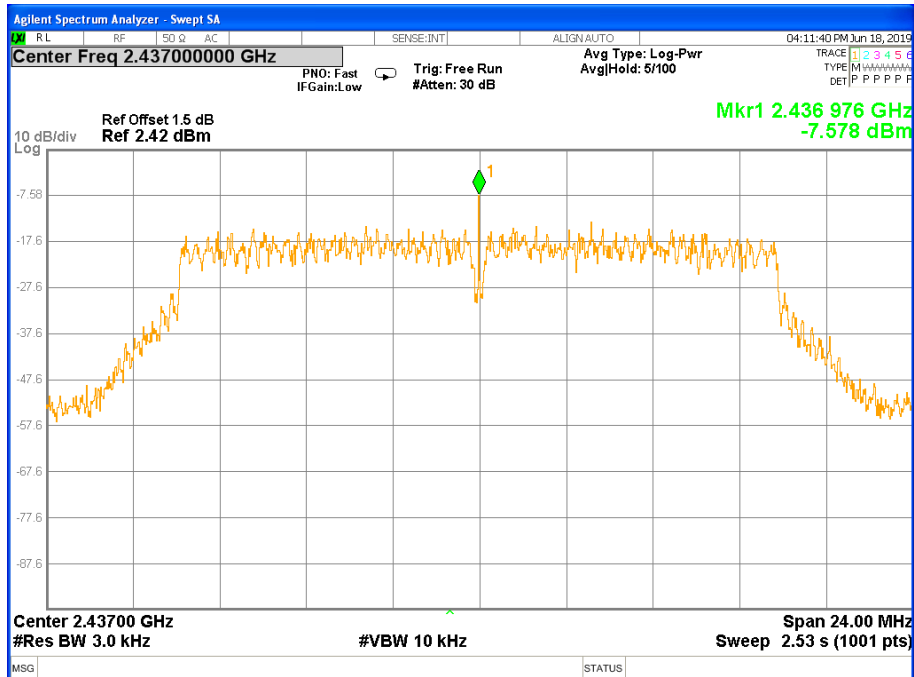

TX CH11

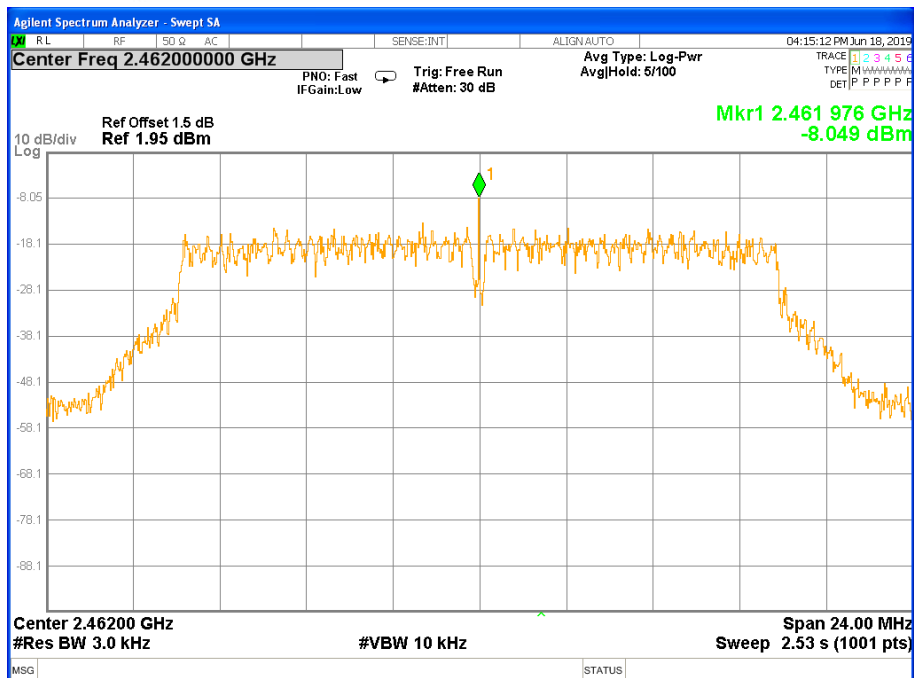



Temperature:	25°C	Relative Humidity:	60%
Test Voltage:	DC 3.3V	Test Mode:	TX n Mode(20M) /CH01, CH06, CH11

Frequency	Power Density	Limit (dBm/3KHz)	Result
	(dBm/3kHz)		
2412 MHz	-8.416	≤8	PASS
2437 MHz	-8.505	≤8	PASS
2462 MHz	-7.907	≤8	PASS

TX CH01

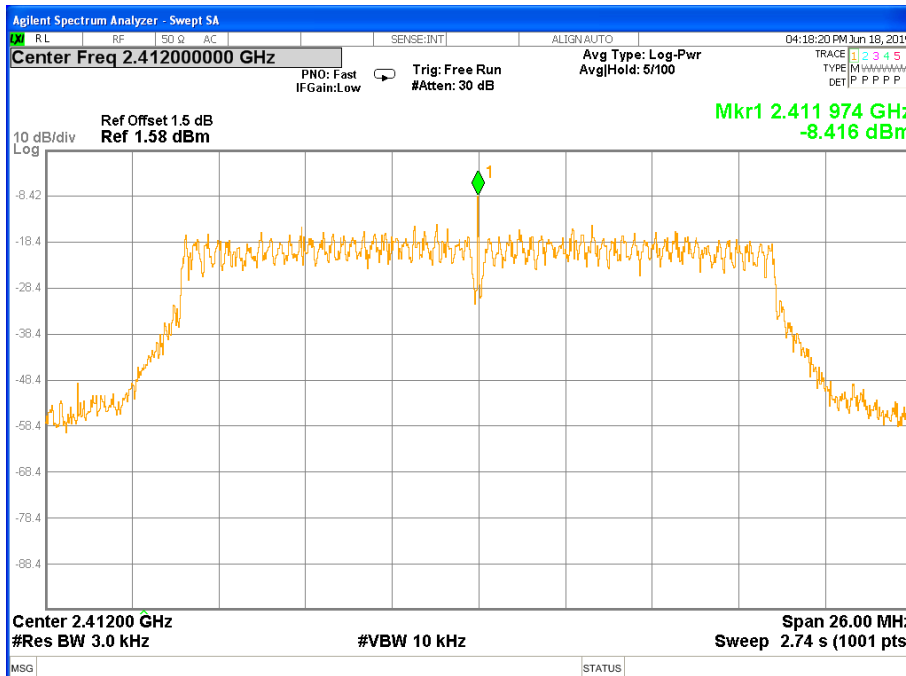



TX CH06

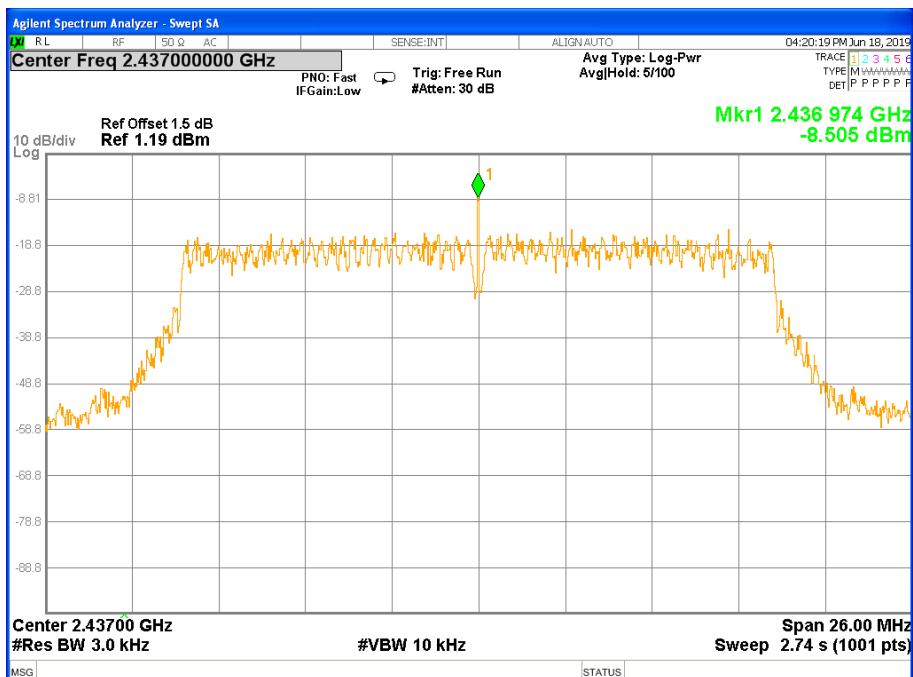

TX CH11

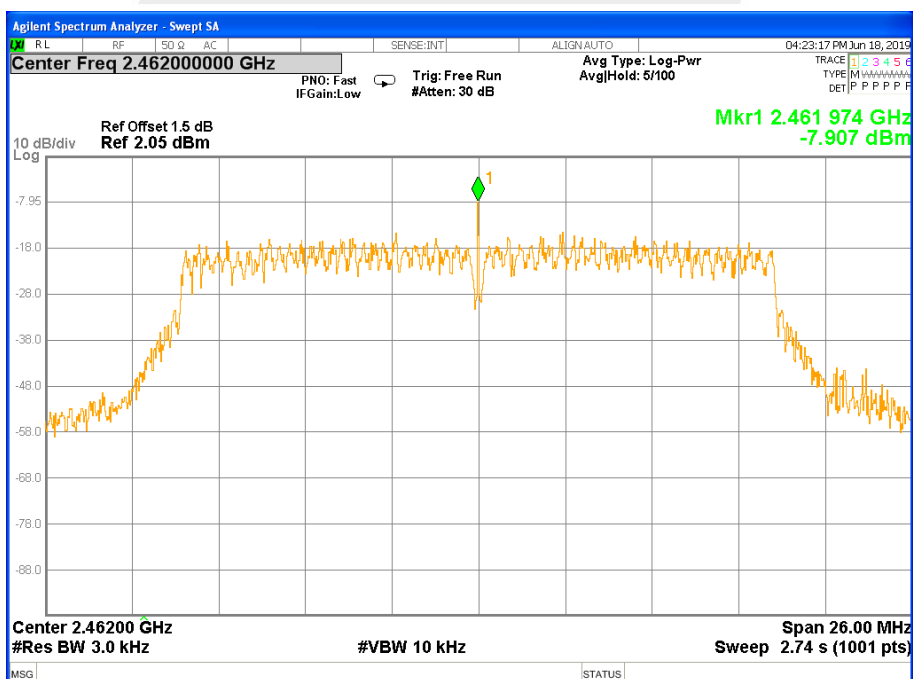



Temperature:	25°C	Relative Humidity:	60%
Test Voltage:	DC 3.3V	Test Mode:	TX n Mode(40M) /CH03, CH06, CH09

Frequency	Power Density	Limit (dBm/3KHz)	Result
	(dBm/3kHz)		
2422 MHz	-11.063	≤8	PASS
2437 MHz	-10.605	≤8	PASS
2452 MHz	-10.847	≤8	PASS

TX CH03

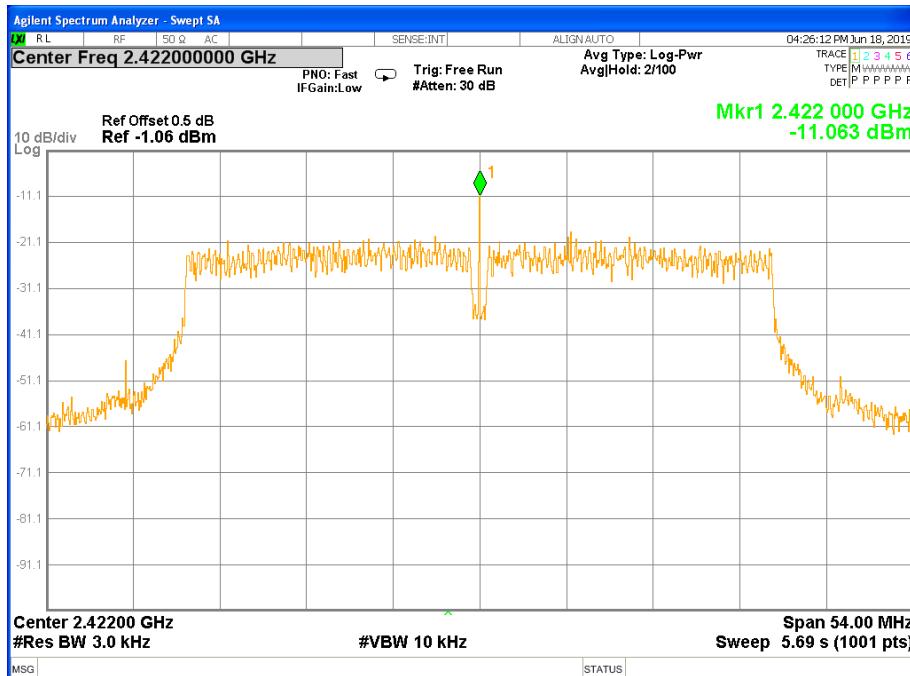



TX CH06

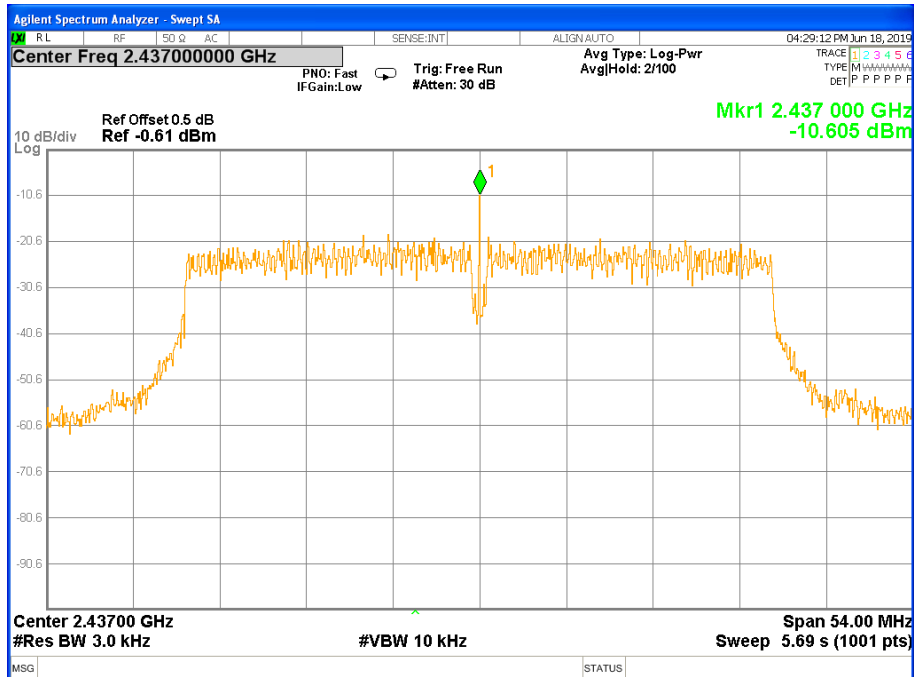

TX CH09

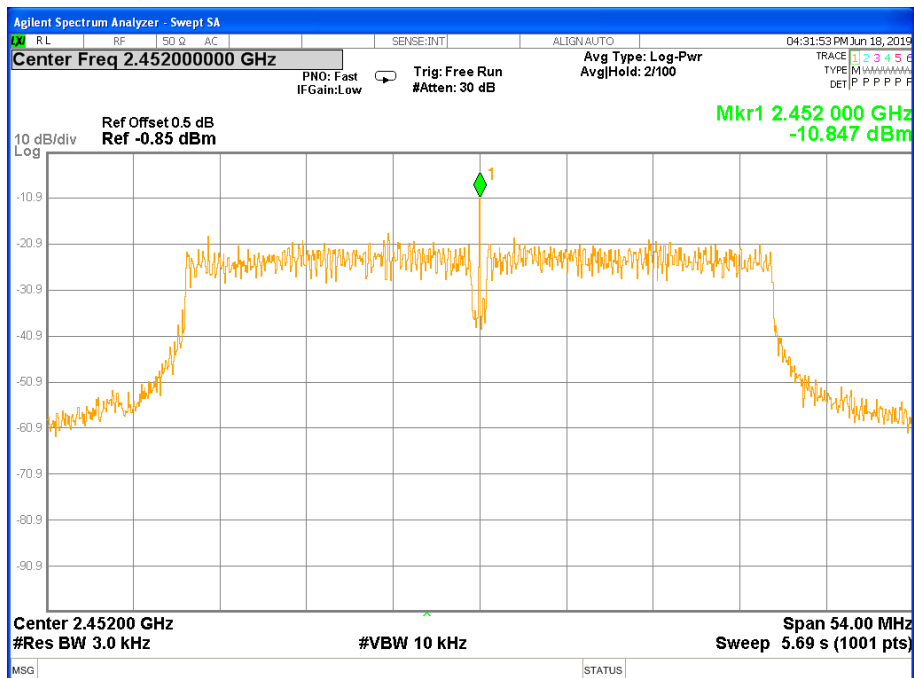



PCB Antenna

Temperature:	25°C	Relative Humidity:	60%
Test Voltage:	DC 3.3V	Test Mode:	TX b Mode /CH01, CH06, CH11

Frequency	Power Density	Limit (dBm/3KHz)	Result
	(dBm/3kHz)		
2412 MHz	-17.282	≤8	PASS
2437 MHz	-16.553	≤8	PASS
2462 MHz	-17.835	≤8	PASS

TX CH01

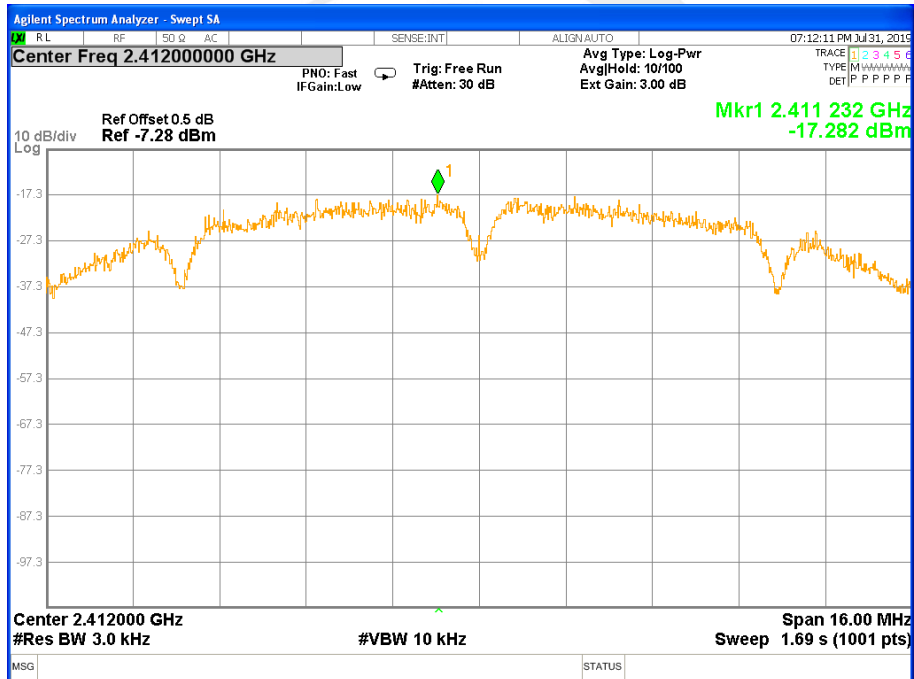



TX CH06

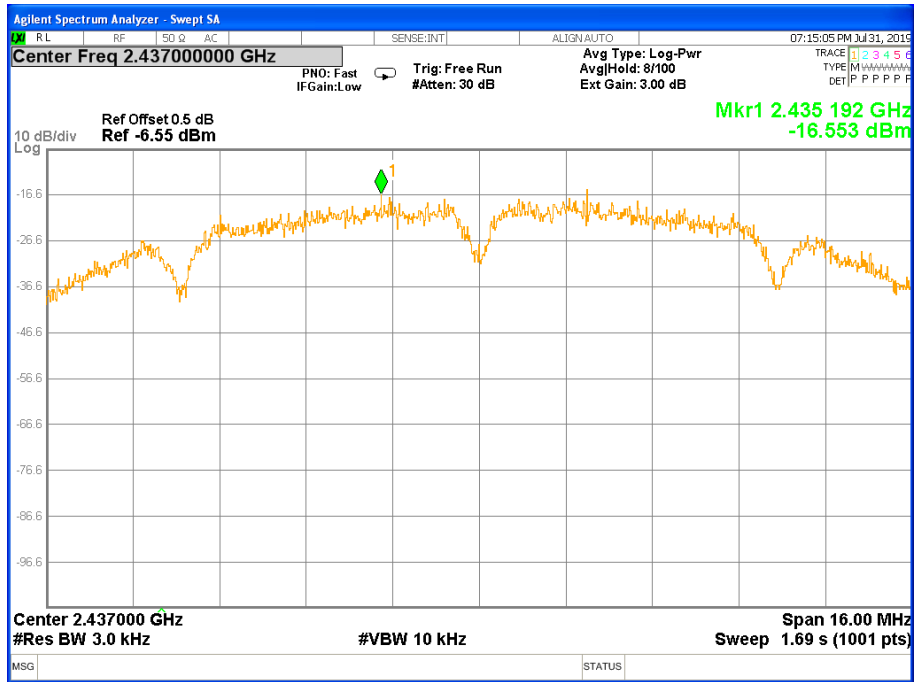

TX CH11

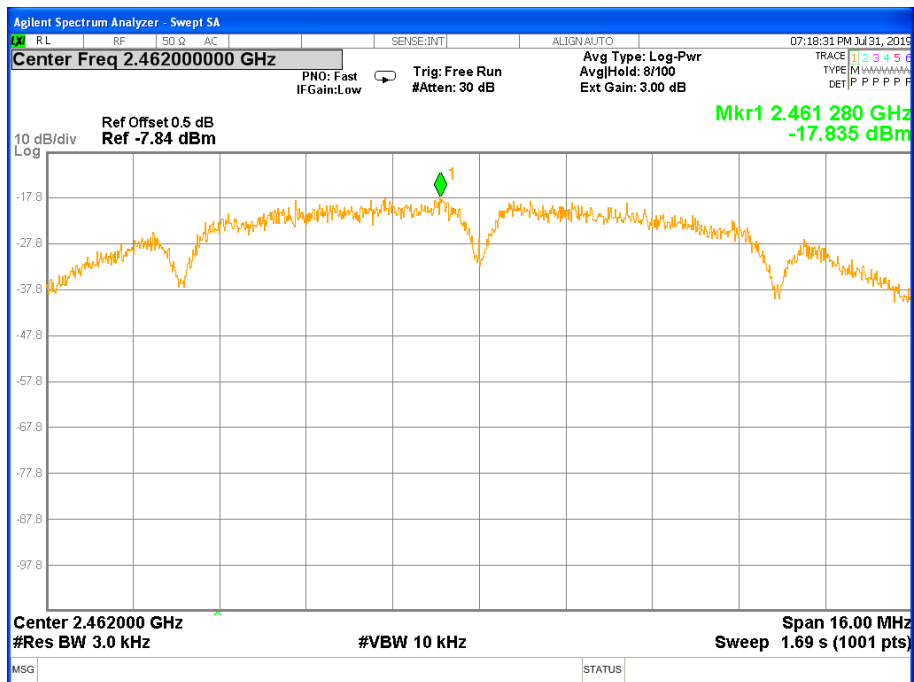



Temperature:	25°C	Relative Humidity:	60%
Test Voltage:	DC 3.3V	Test Mode:	TX g Mode /CH01, CH06, CH11

Frequency	Power Density	Limit (dBm/3KHz)	Result
	(dBm/3kHz)		
2412 MHz	-22.017	≤8	PASS
2437 MHz	-20.984	≤8	PASS
2462 MHz	-21.183	≤8	PASS

TX CH01

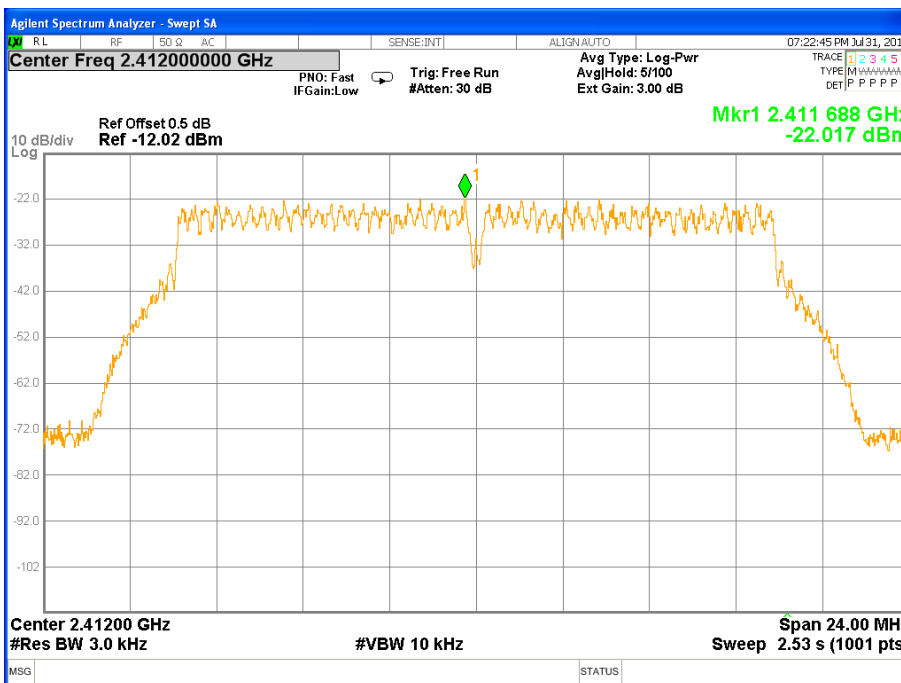



TX CH06

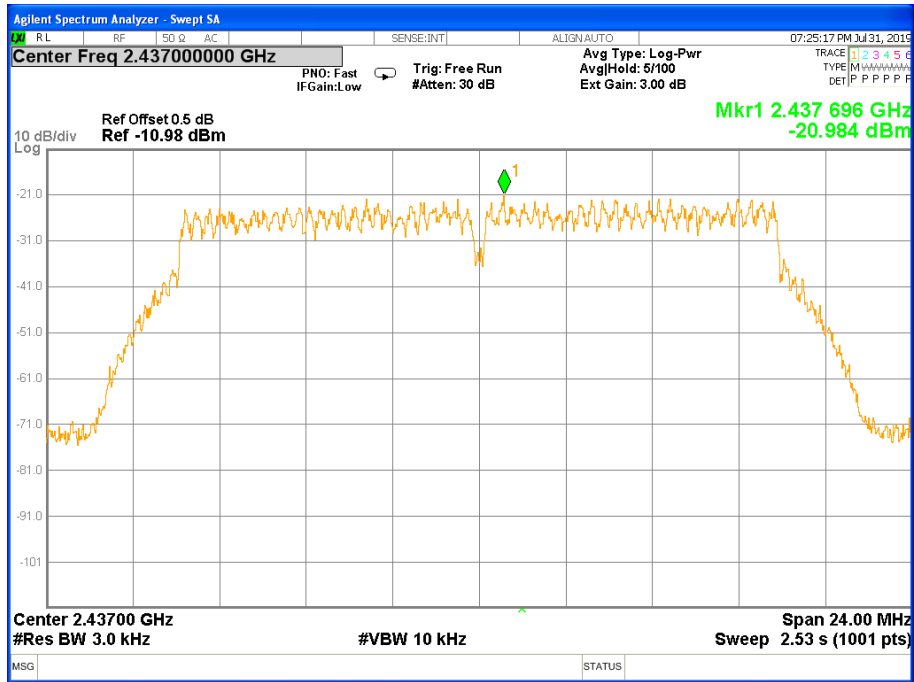

TX CH11

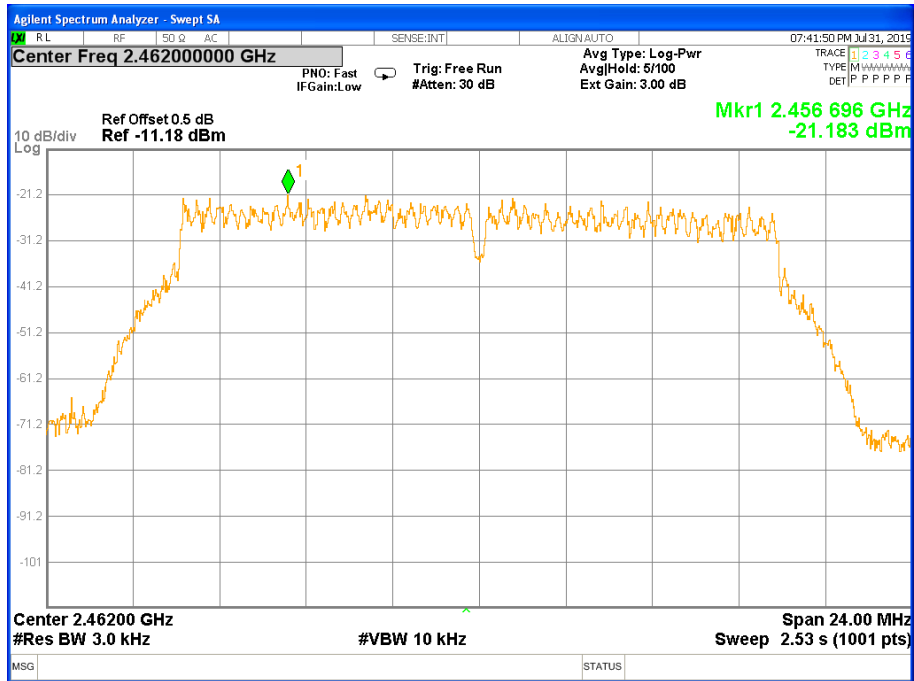



Temperature:	25°C	Relative Humidity:	60%
Test Voltage:	DC 3.3V	Test Mode:	TX n Mode(20M) /CH01, CH06, CH11

Frequency	Power Density	Limit (dBm/3KHz)	Result
	(dBm/3kHz)		
2412 MHz	-23.654	≤8	PASS
2437 MHz	-23.1	≤8	PASS
2462 MHz	-23.998	≤8	PASS

TX CH01

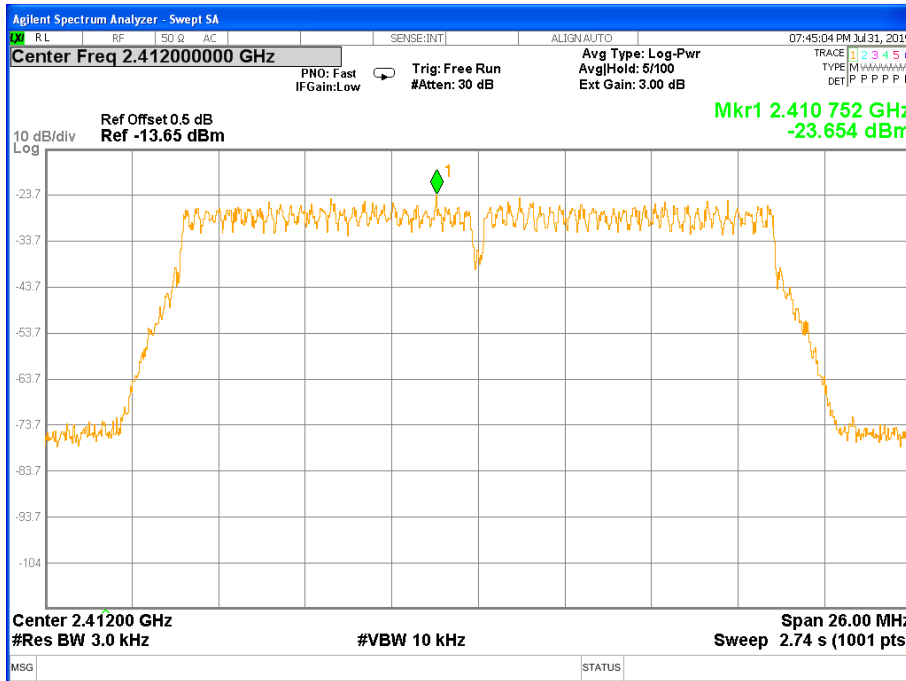



TX CH06

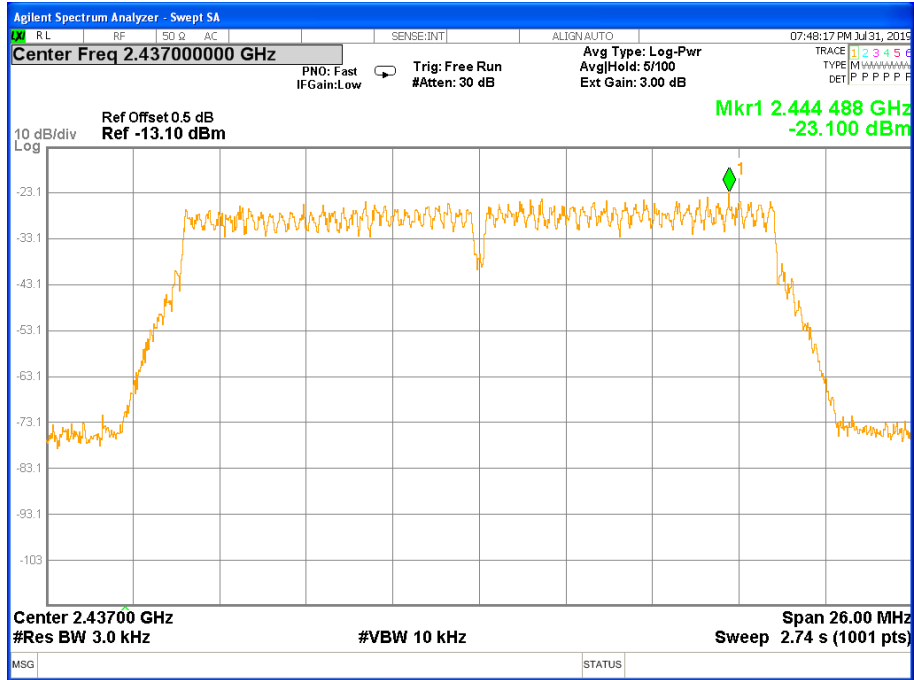

TX CH11

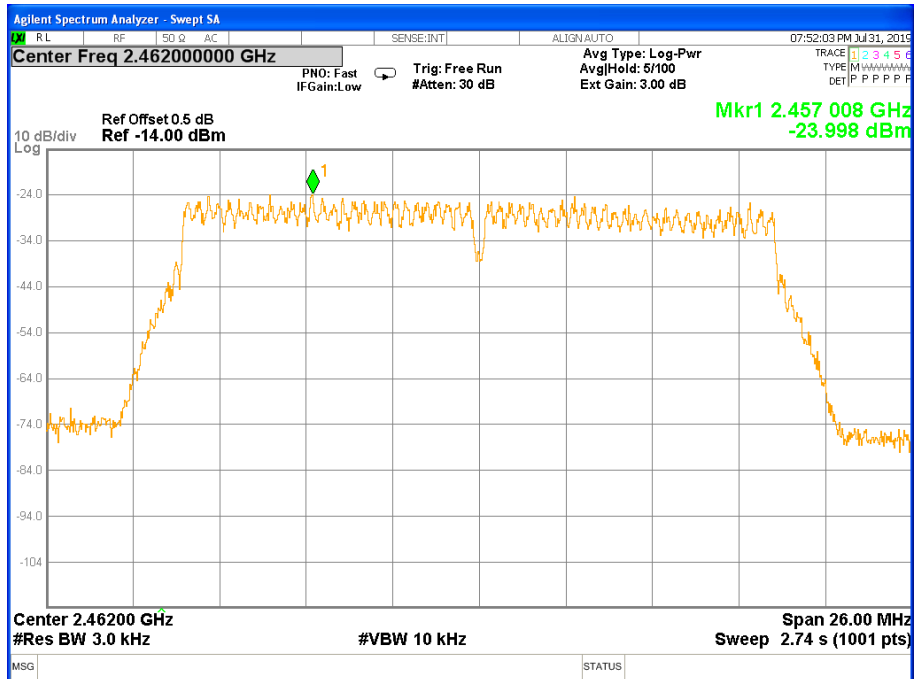



Temperature:	25°C	Relative Humidity:	60%
Test Voltage:	DC 3.3V	Test Mode:	TX n Mode(40M) /CH03, CH06, CH09

Frequency	Power Density	Limit (dBm/3KHz)	Result
	(dBm/3kHz)		
2422 MHz	-27.057	≤8	PASS
2437 MHz	-26.706	≤8	PASS
2452 MHz	-26.888	≤8	PASS

TX CH03

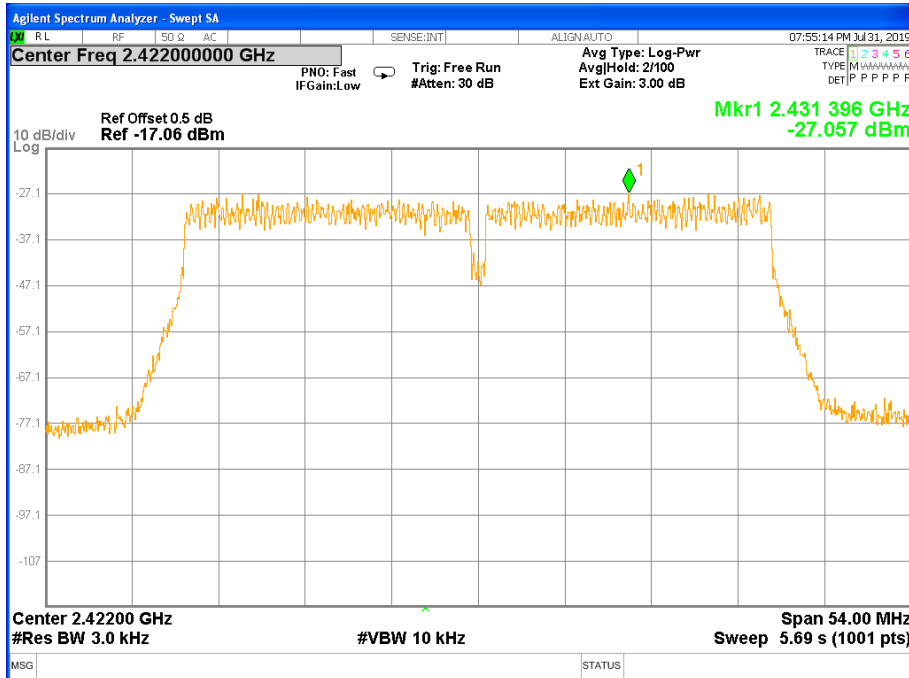



TX CH06

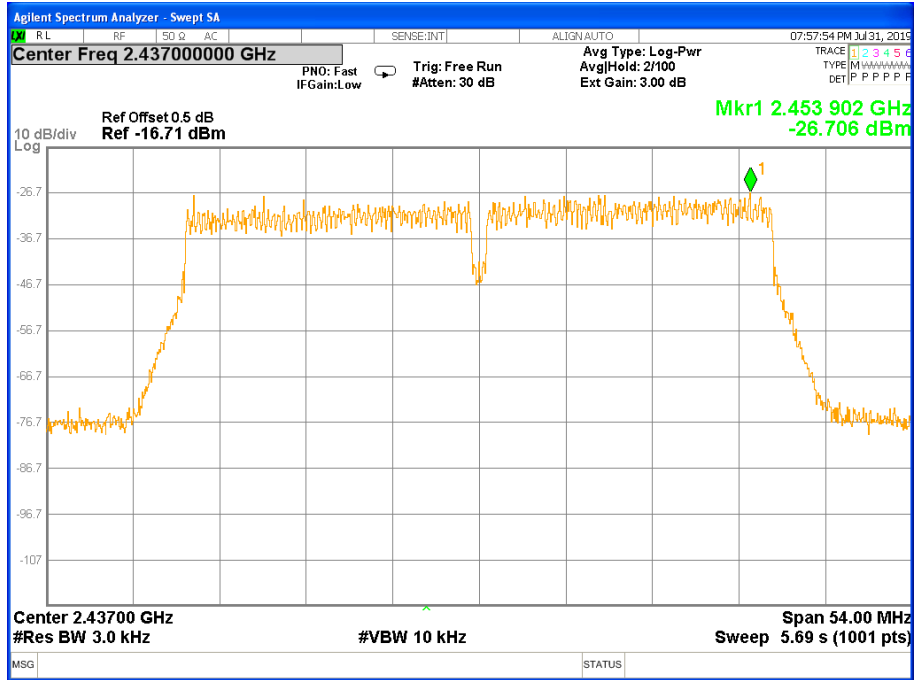

TX CH09

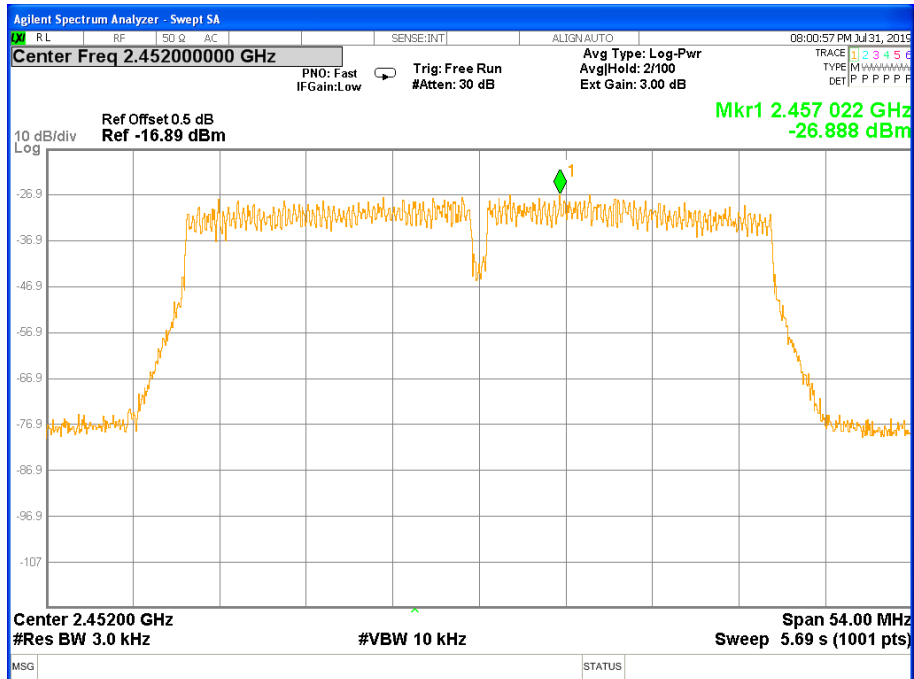



6. BANDWIDTH TEST

6.1 LIMIT

FCC Part15.247,Subpart C				
Section	Test Item	Limit	Frequency Range (MHz)	Result
15.247(a)(2)	Bandwidth	$\geq 500\text{KHz}$ (6dB bandwidth)	2400-2483.5	PASS

6.2 TEST PROCEDURE

The automatic bandwidth measurement capability of an instrument may be employed using the X dB bandwidth mode with X set to 6 dB, if the functionality described above (i.e., RBW = 100 kHz, VBW \geq 3RBW, peak detector with maximum hold) is implemented by the instrumentation function. When using this capability, care shall be taken so that the bandwidth measurement is not influenced by any intermediate power nulls in the fundamental emission that might be \geq 6 dB.

6.3 DEVIATION FROM STANDARD

No deviation.

6.4 TEST SETUP

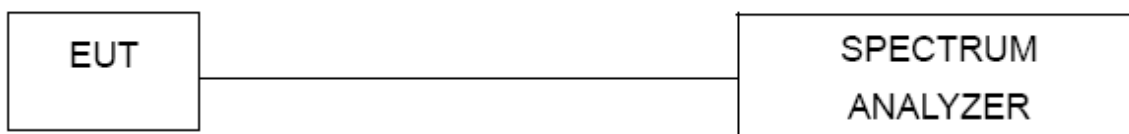

6.5 EUT OPERATION CONDITIONS

The EUT tested system was configured as the statements of 2.3 Unless otherwise a special operating condition is specified in the follows during the testing.



6.6 TEST RESULTS

External Antenna

Temperature:	25°C	Relative Humidity:	60%
Test Voltage:	DC 3.3V	Test Mode:	TX b Mode /CH01, CH06, CH11

Remark: PEAK DETECTOR IS USED

Frequency	6dB Bandwidth	Channel Separation	Result
	(MHz)	(KHz)	
2412 MHz	9.550	≥500KHz	PASS
2437 MHz	9.082	≥500KHz	PASS
2462 MHz	10.030	≥500KHz	PASS

TX CH 01

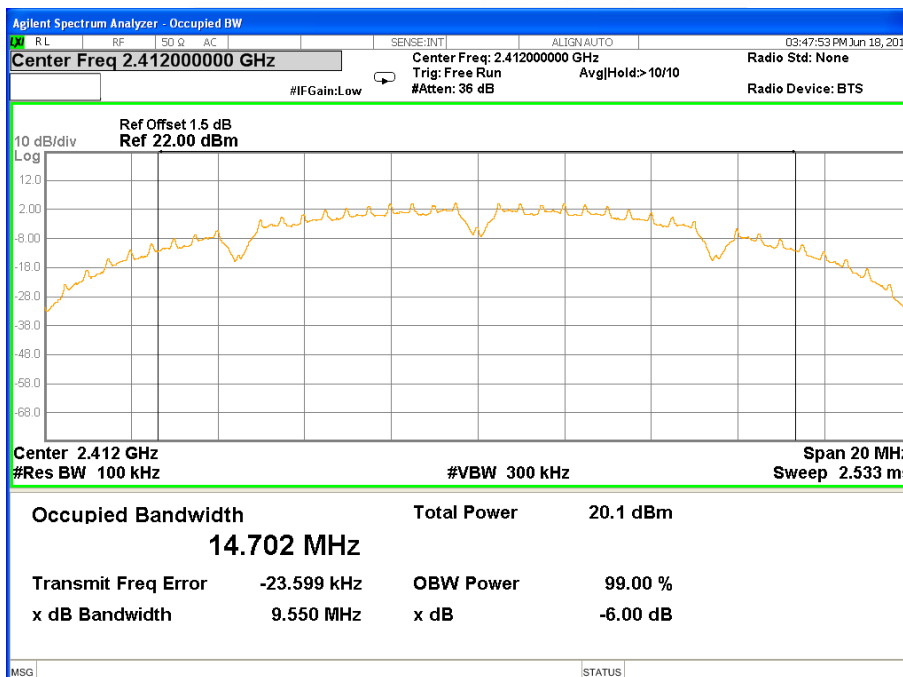



TX CH 06

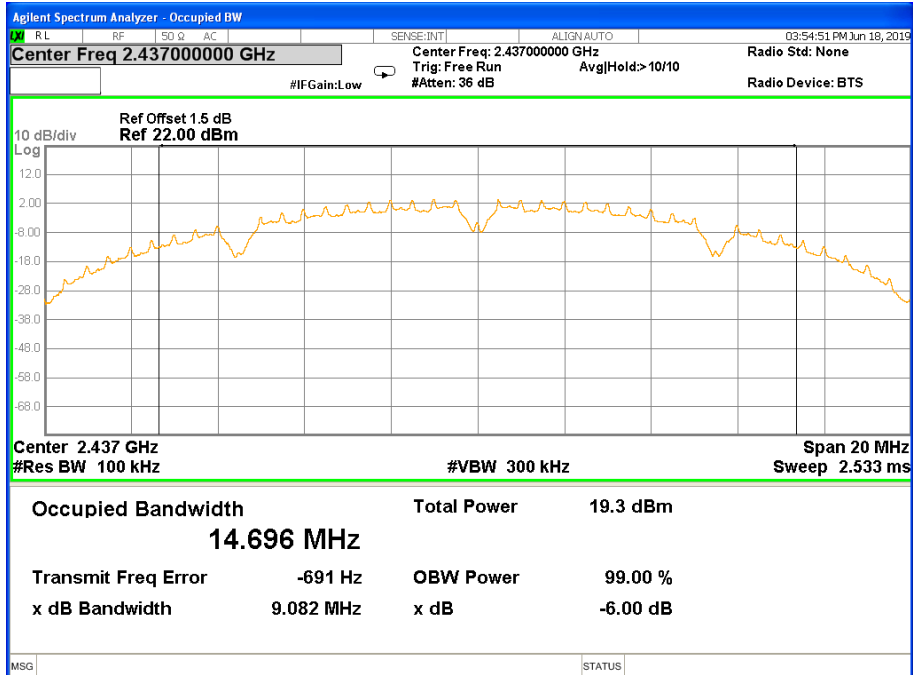

TX CH 11

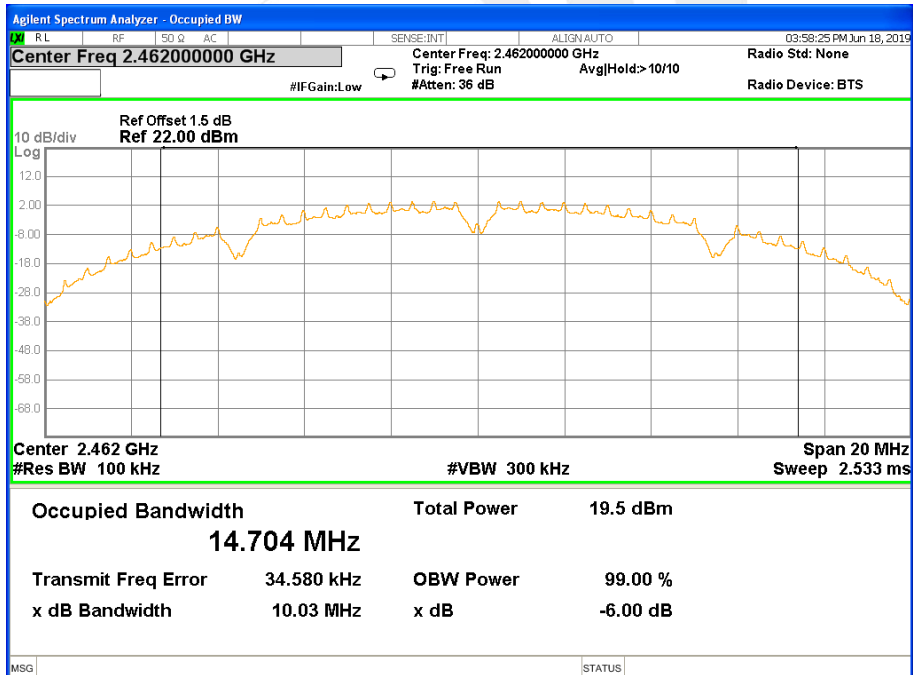



Temperature:	25°C	Relative Humidity:	60%
Test Voltage:	DC 3.3V	Test Mode:	TX g Mode /CH01, CH06, CH11

Frequency	6dB Bandwidth	Channel Separation	Result
	(MHz)	(KHz)	
2412 MHz	16.31	≥500KHz	PASS
2437 MHz	16.30	≥500KHz	PASS
2462 MHz	16.30	≥500KHz	PASS

TX CH 01

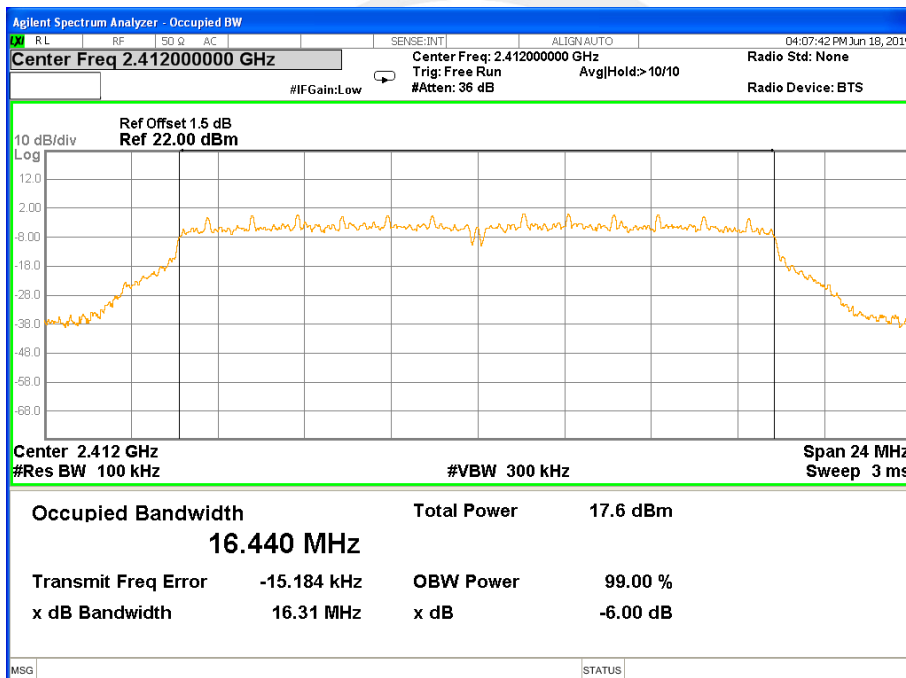



TX CH 06

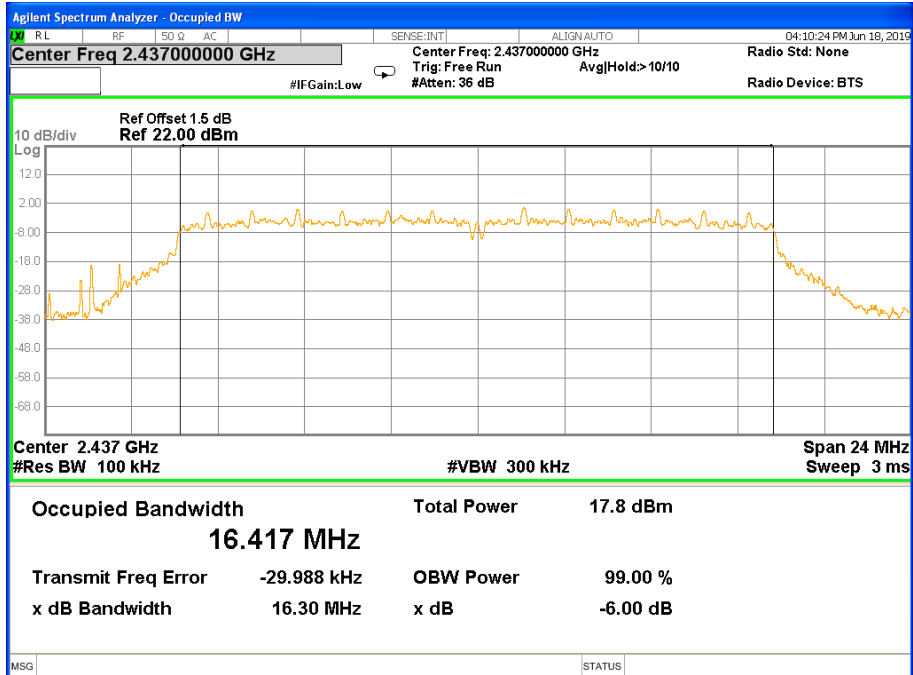

TX CH 11

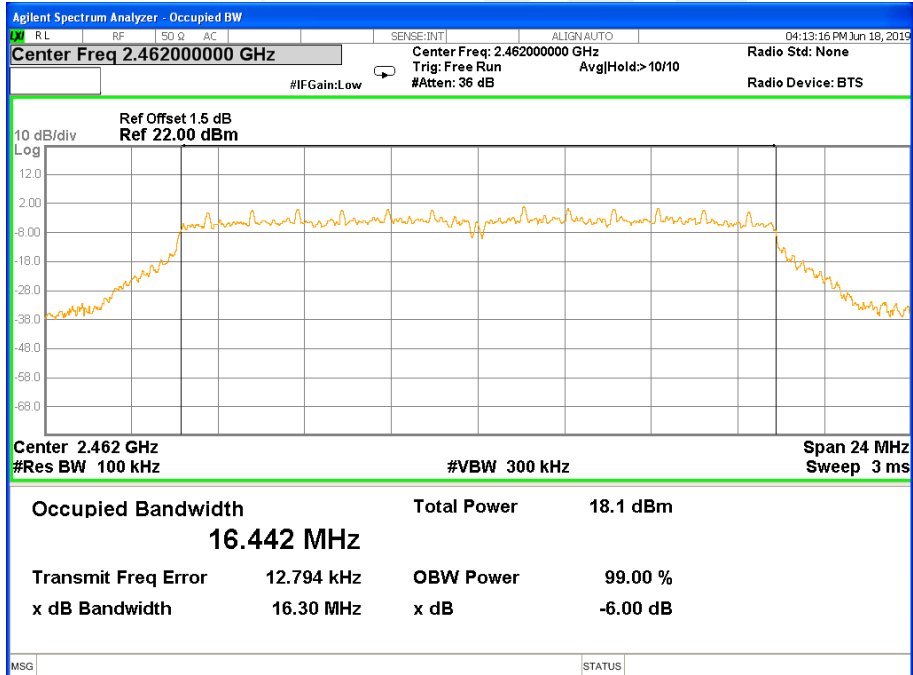



Temperature:	25°C	Relative Humidity:	60%
Test Voltage:	DC 3.3V	Test Mode:	TX n Mode(20M) /CH01, CH06, CH11

Frequency	6dB Bandwidth	Channel Separation	Result
	(MHz)	(KHz)	
2412 MHz	17.53	≥500KHz	PASS
2437 MHz	17.54	≥500KHz	PASS
2462 MHz	17.54	≥500KHz	PASS

TX CH 01

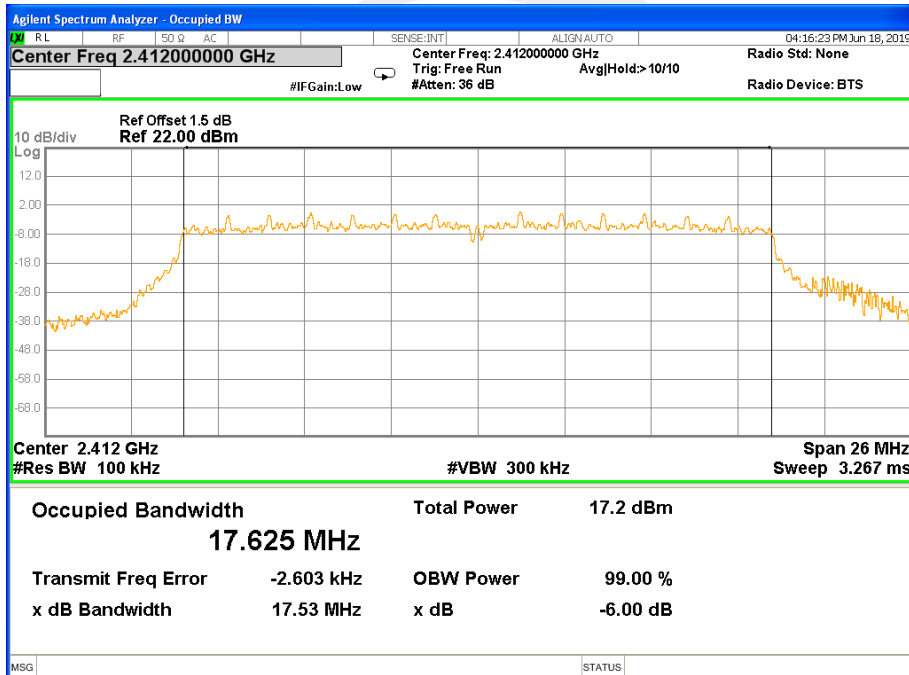



TX CH 06

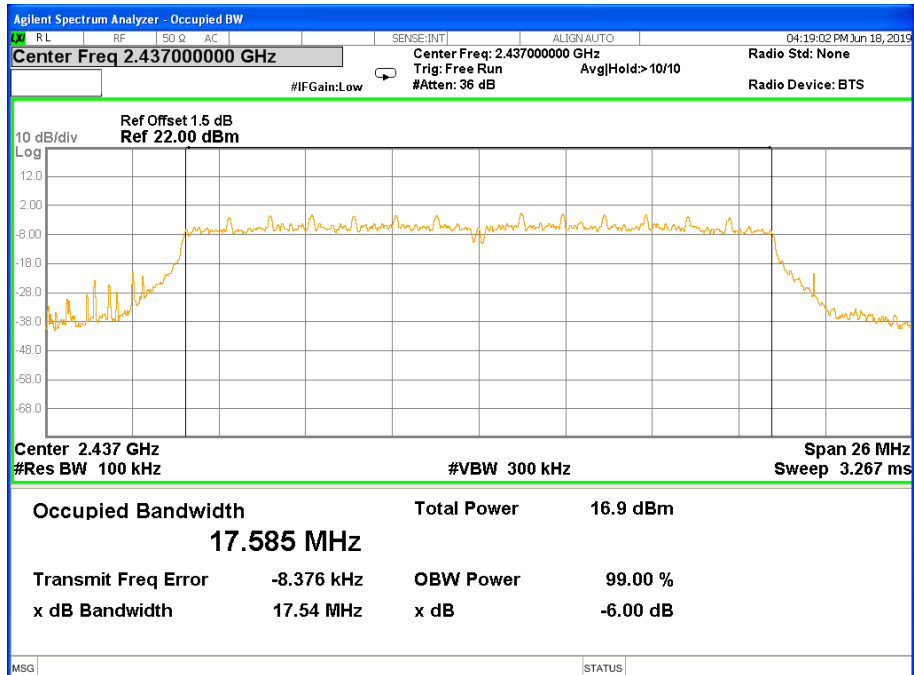

TX CH 11

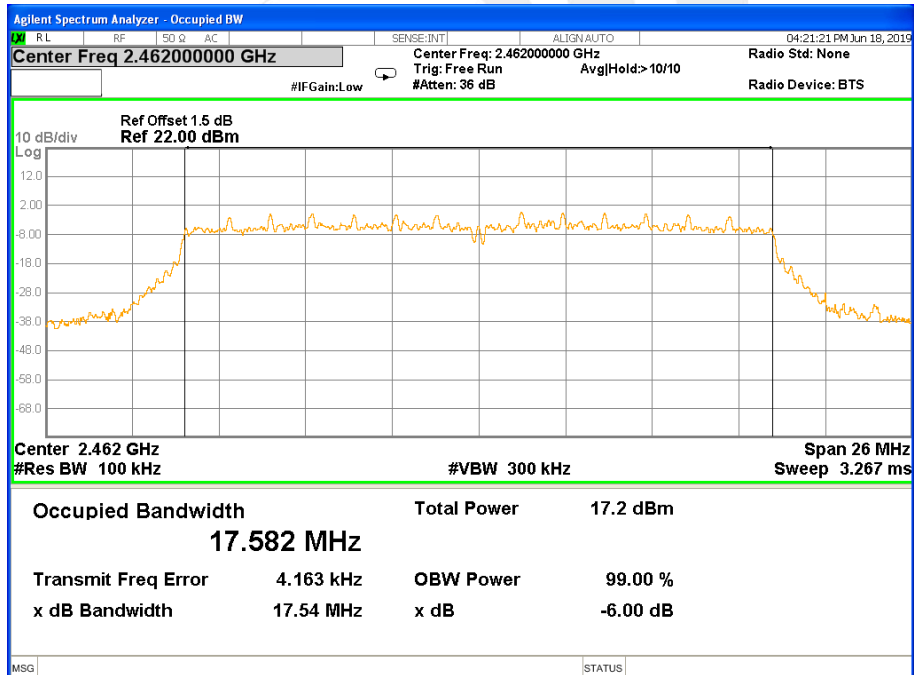



Temperature:	25°C	Relative Humidity:	60%
Test Voltage:	DC 3.3V	Test Mode:	TX n Mode(40M) /CH03, CH06, CH09

Frequency	6dB Bandwidth	Channel Separation	Result
	(MHz)	(KHz)	
2422 MHz	35.74	≥500KHz	PASS
2437 MHz	35.91	≥500KHz	PASS
2452 MHz	35.87	≥500KHz	PASS

TX CH 03

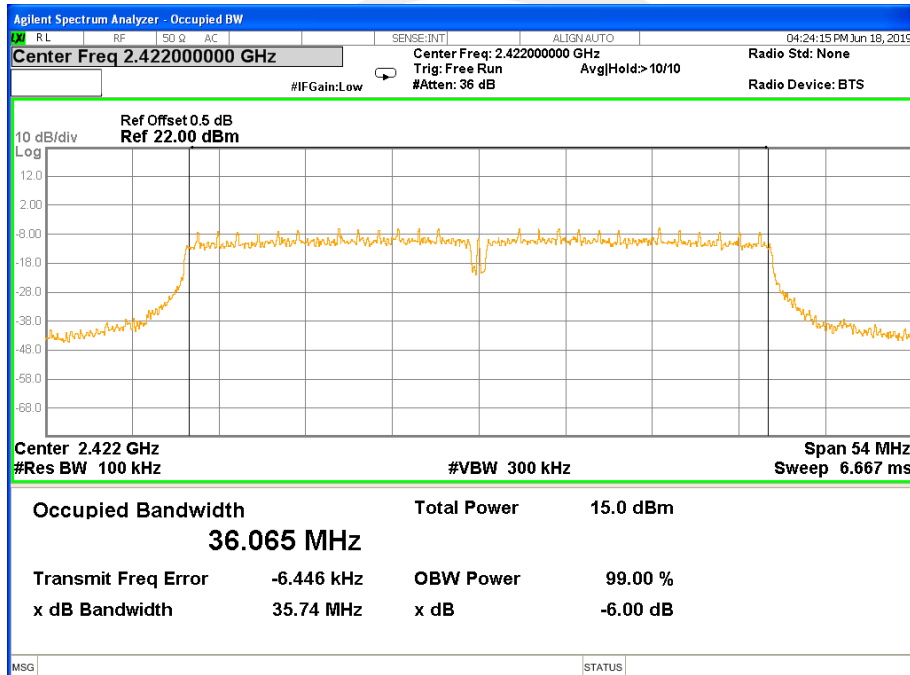



TX CH 06

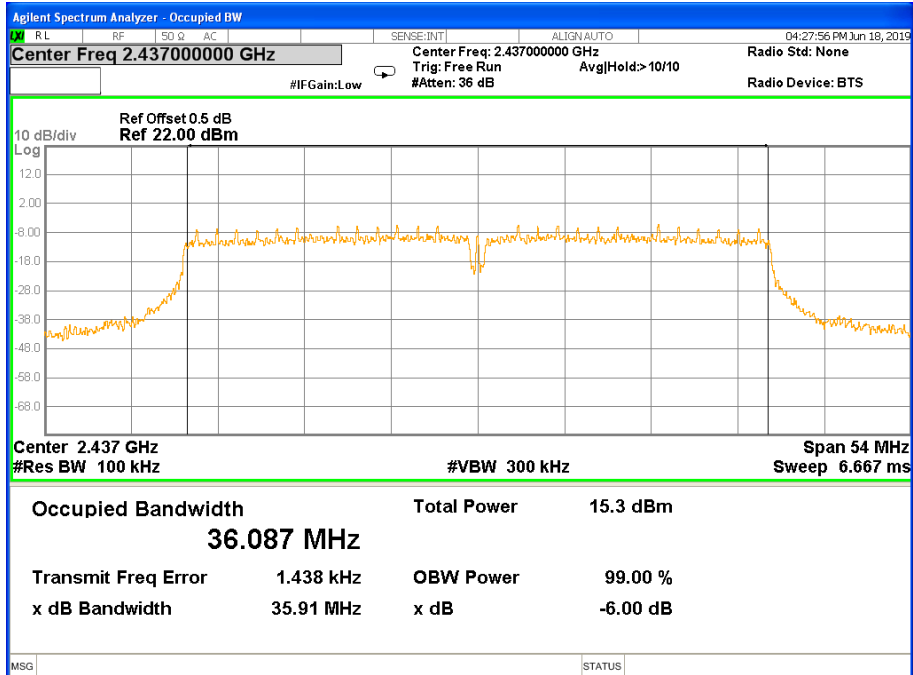

TX CH 09

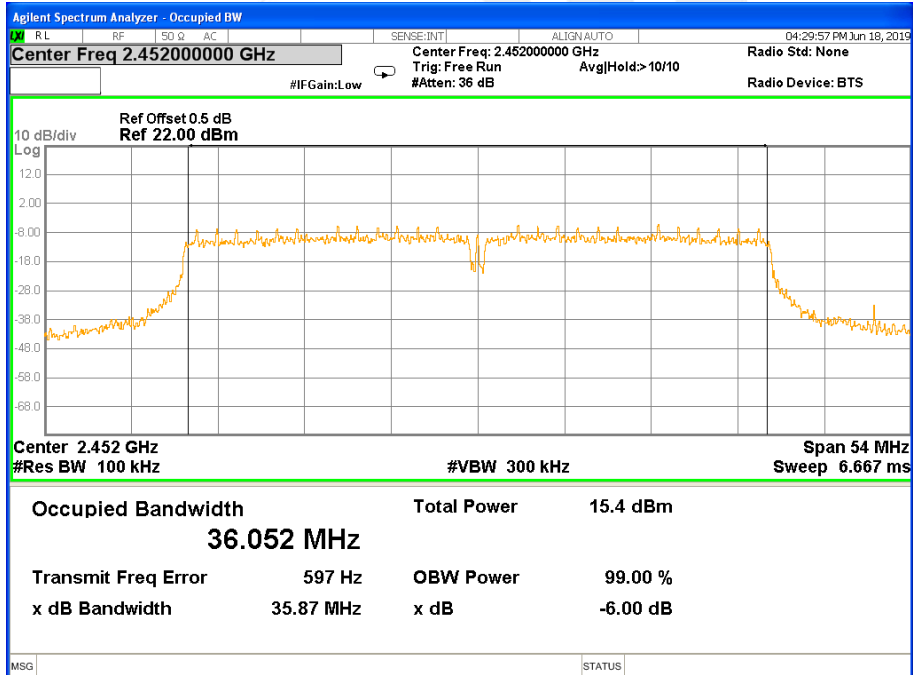



PCB Antenna

Temperature:	25°C	Relative Humidity:	60%
Test Voltage:	DC 3.3V	Test Mode:	TX b Mode /CH01, CH06, CH11

Remark: PEAK DETECTOR IS USED

Frequency	6dB Bandwidth	Channel Separation	Result
	(MHz)	(KHz)	
2412 MHz	10.07	≥500KHz	PASS
2437 MHz	10.07	≥500KHz	PASS
2462 MHz	9.563	≥500KHz	PASS

TX CH 01

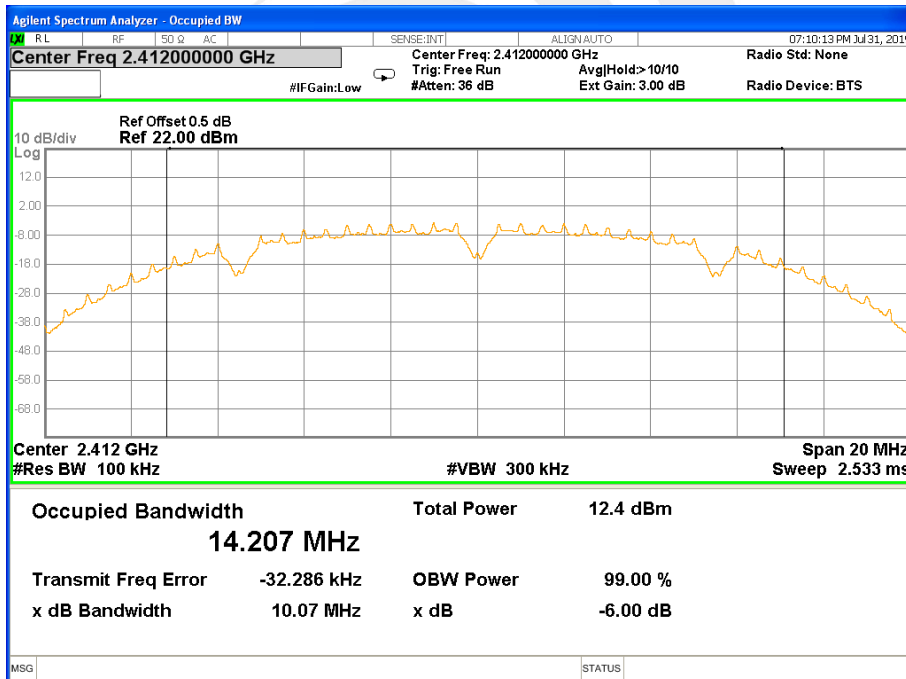



TX CH 06

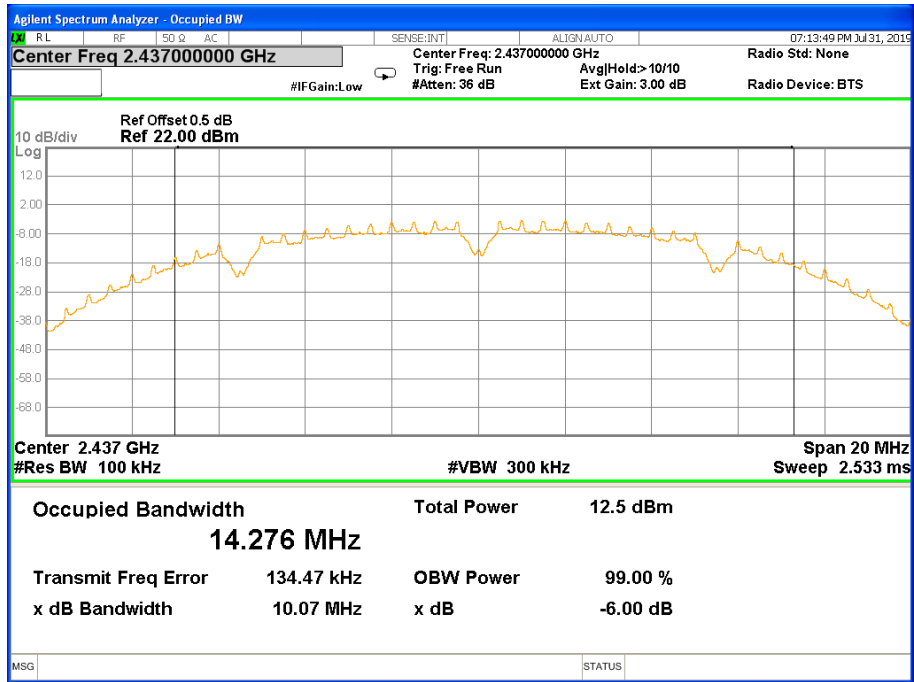

TX CH 11

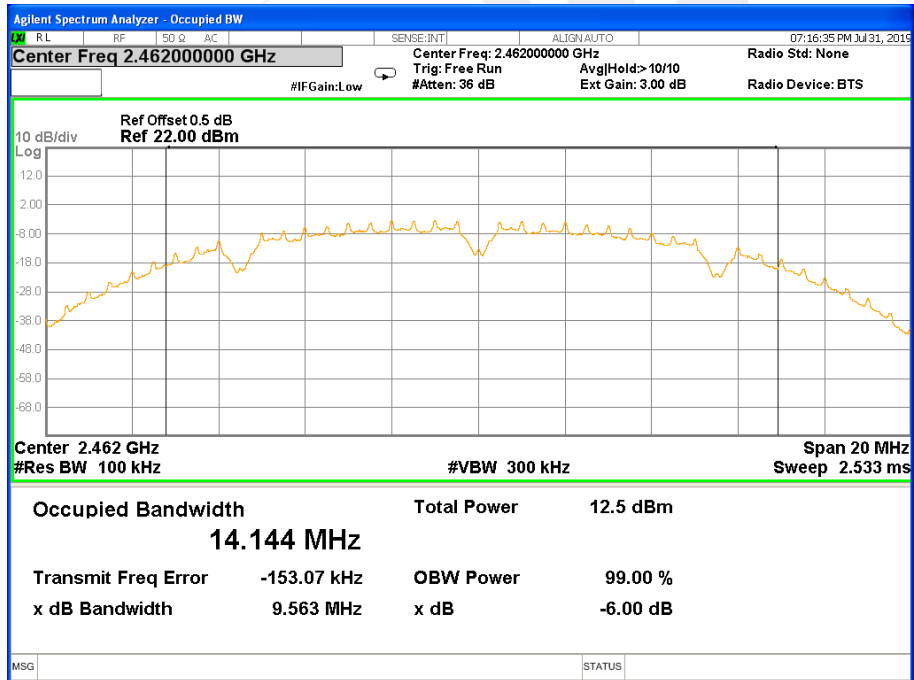



Temperature:	25°C	Relative Humidity:	60%
Test Voltage:	DC 3.3V	Test Mode:	TX g Mode /CH01, CH06, CH11

Frequency	6dB Bandwidth	Channel Separation	Result
	(MHz)	(KHz)	
2412 MHz	16.38	≥500KHz	PASS
2437 MHz	16.41	≥500KHz	PASS
2462 MHz	16.33	≥500KHz	PASS

TX CH 01

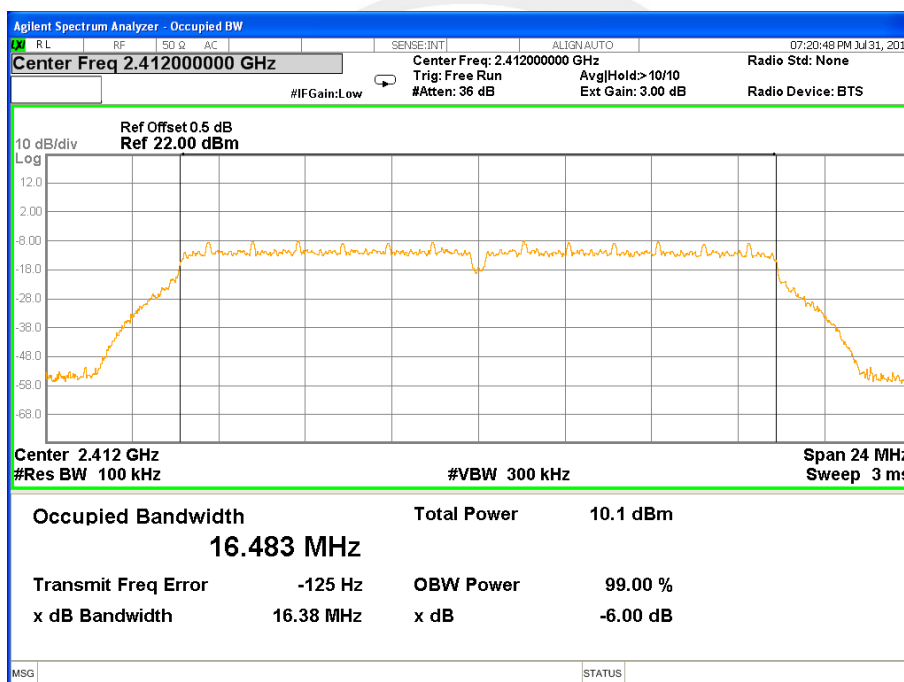



TX CH 06

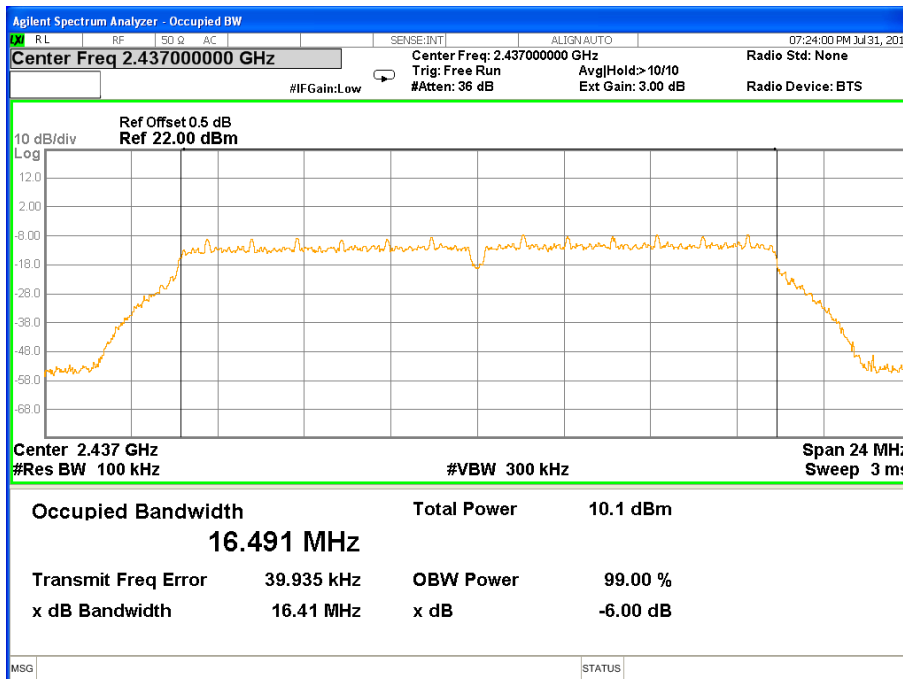

TX CH 11

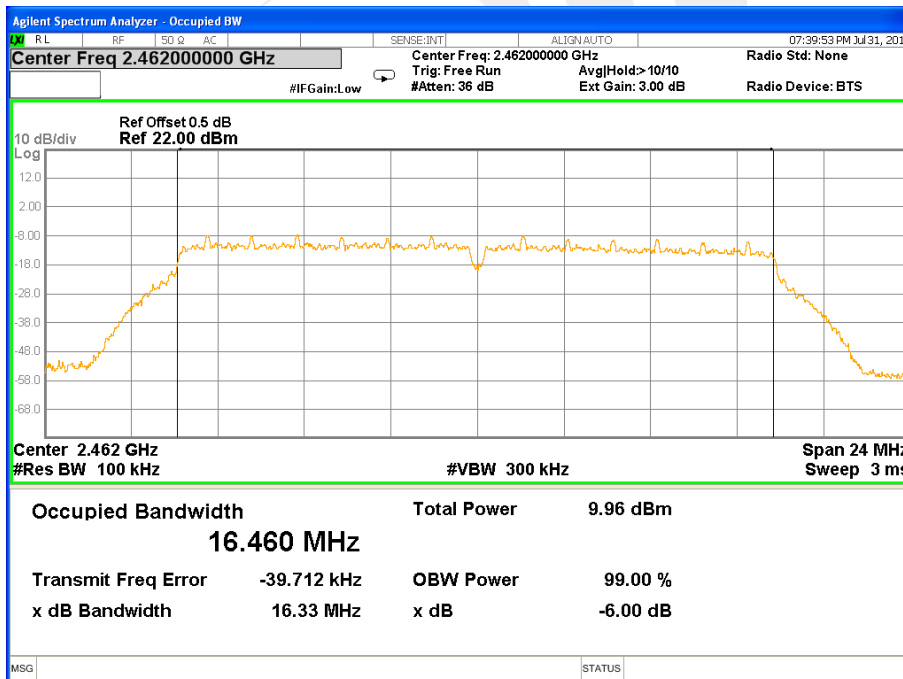



Temperature:	25°C	Relative Humidity:	60%
Test Voltage:	DC 3.3V	Test Mode:	TX n Mode(20M) /CH01, CH06, CH11

Frequency	6dB Bandwidth	Channel Separation	Result
	(MHz)	(KHz)	
2412 MHz	17.61	≥500KHz	PASS
2437 MHz	17.59	≥500KHz	PASS
2462 MHz	17.34	≥500KHz	PASS

TX CH 01

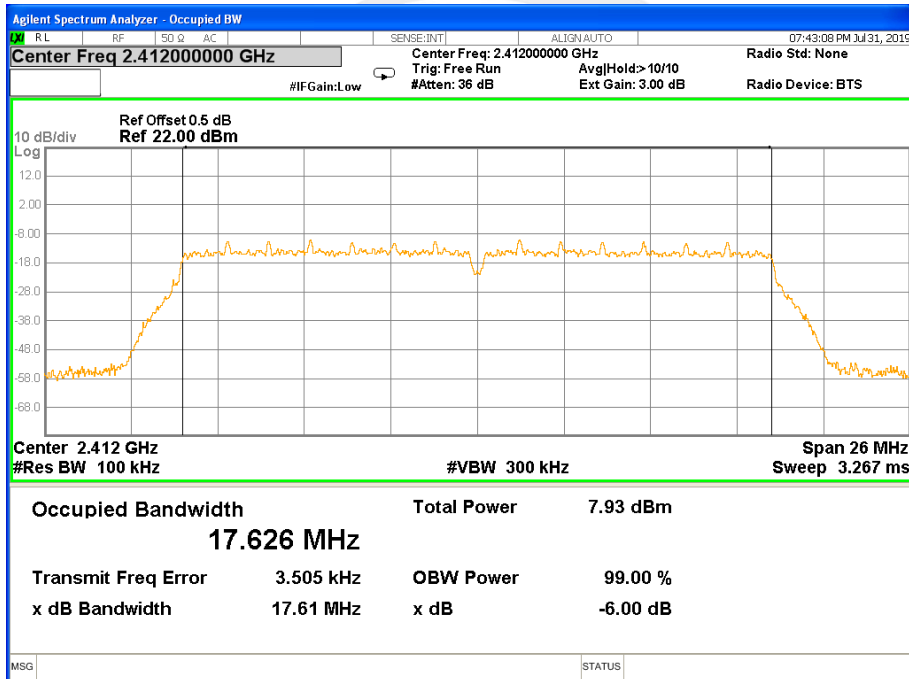



TX CH 06

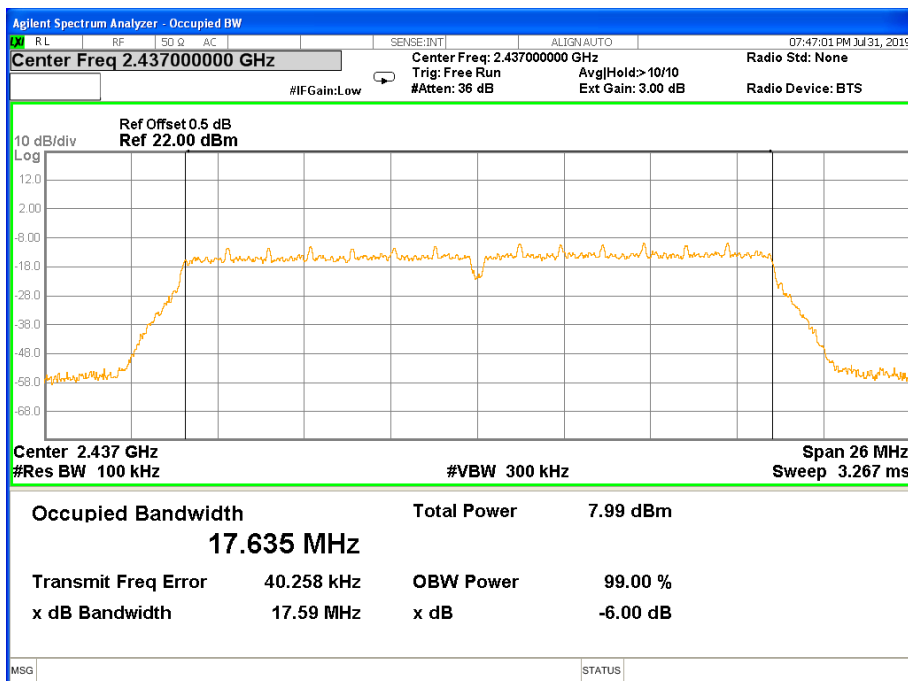

TX CH 11

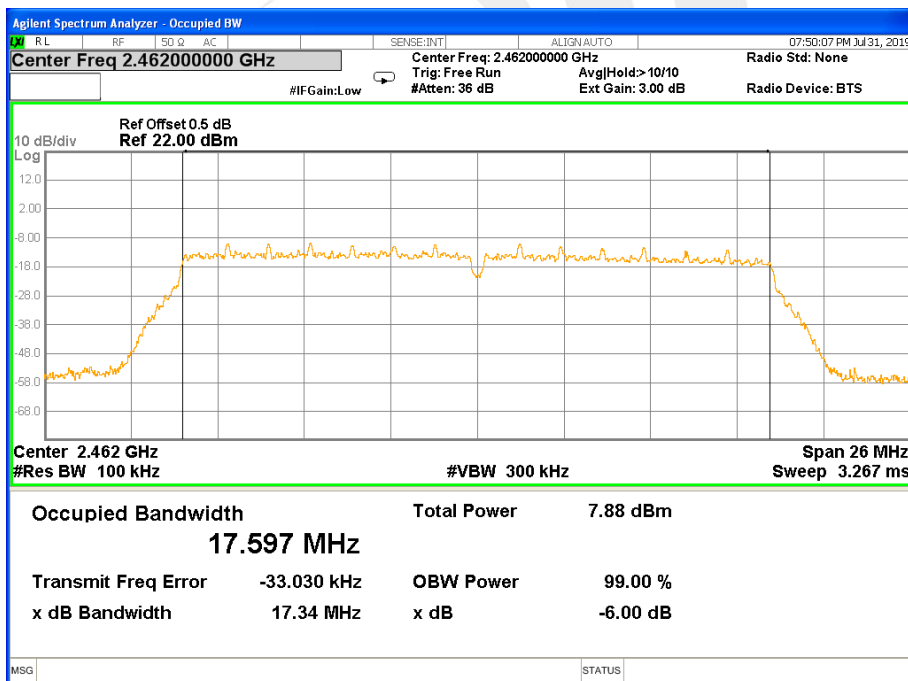



Temperature:	25°C	Relative Humidity:	60%
Test Voltage:	DC 3.3V	Test Mode:	TX n Mode(40M) /CH03, CH06, CH09

Frequency	6dB Bandwidth	Channel Separation	Result
	(MHz)	(KHz)	
2422 MHz	36.09	≥500KHz	PASS
2437 MHz	35.75	≥500KHz	PASS
2452 MHz	35.17	≥500KHz	PASS

TX CH 03

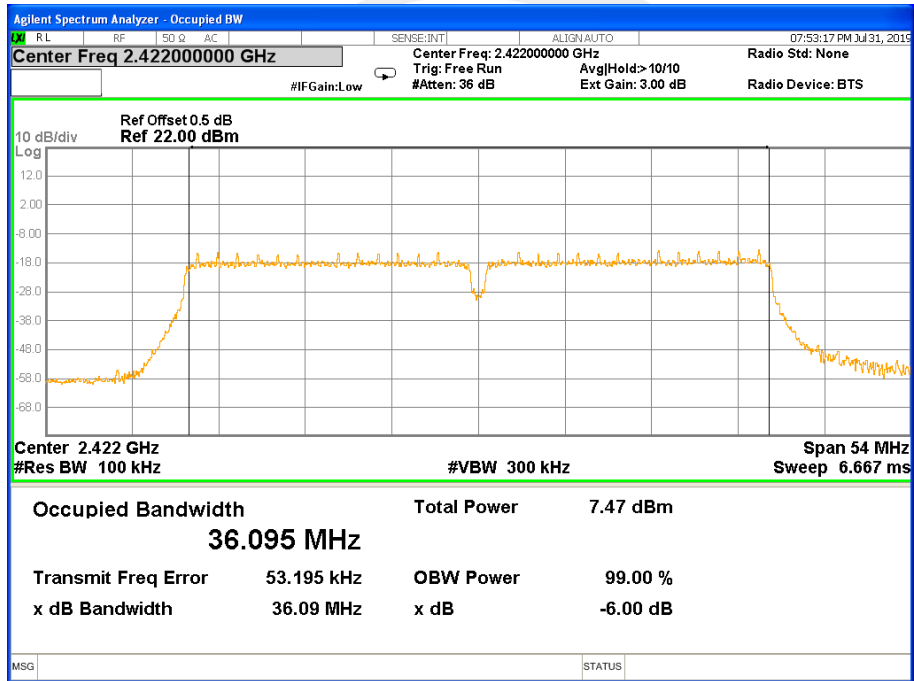



TX CH 06

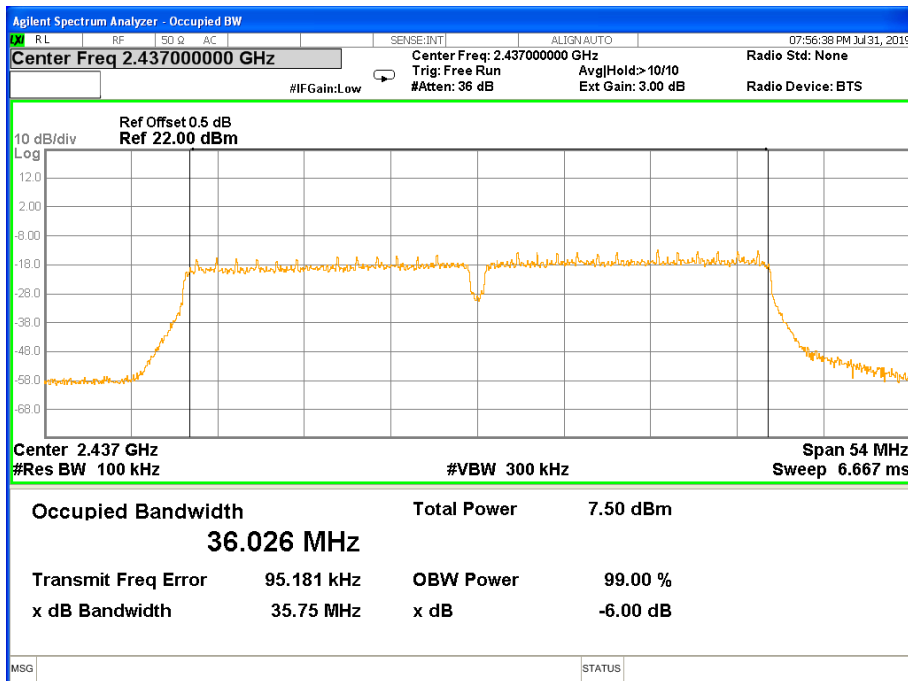

TX CH 09

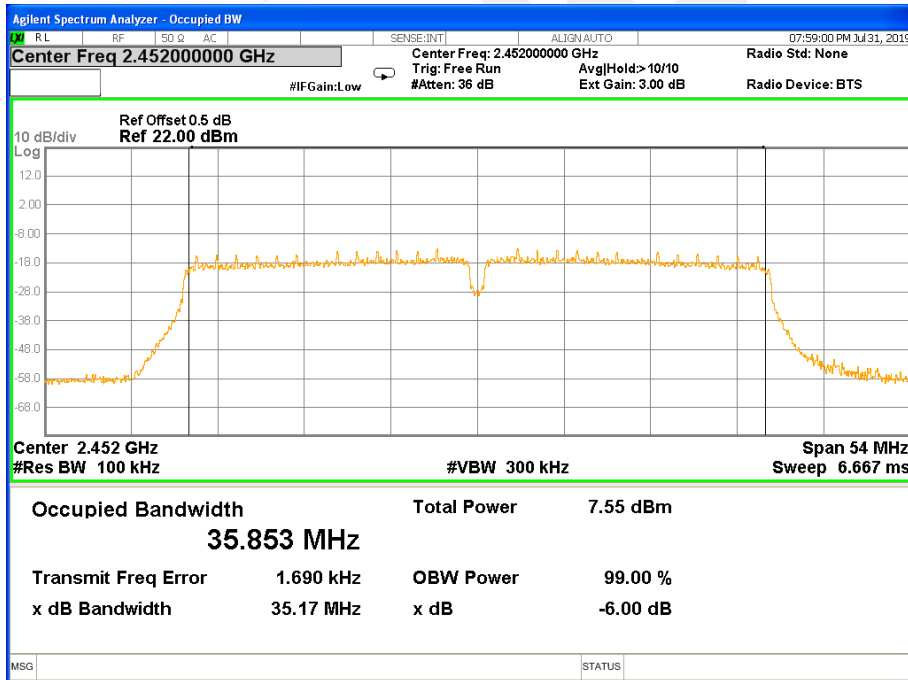



7. PEAK OUTPUT POWER TEST

7.1 LIMIT

FCC Part15.247,Subpart C				
Section	Test Item	Limit	Frequency Range (MHz)	Result
15.247(b)(3)	Output Power	1 watt or 30dBm	2400-2483.5	PASS

7.2 TEST PROCEDURE

- a. The EUT was directly connected to the Power Sensor&PC

7.3 DEVIATION FROM STANDARD

No deviation.

7.4 TEST SETUP



7.5 EUT OPERATION CONDITIONS

The EUT tested system was configured as the statements of 2.3 Unless otherwise a special operating condition is specified in the follows during the testing.



7.6 TEST RESULTS

Temperature:	25°C	Relative Humidity:	60%
Test Voltage:	DC 3.3V		

External Antenna

TX 802.11b Mode				
Test Channe	Frequency	Peak Conducted Output Power	Average Conducted Output Power	LIMIT
	(MHz)	(dBm)	(dBm)	dBm
CH01	2412	14.01	11.13	30
CH06	2437	14.45	11.51	30
CH11	2462	14.64	11.67	30

TX 802.11g Mode				
Test Channe	Frequency	Peak Conducted Output Power	Average Conducted Output Power	LIMIT
	(MHz)	(dBm)	(dBm)	dBm
CH01	2412	19.22	7.72	30
CH06	2437	19.49	8.05	30
CH11	2462	19.39	8.43	30

TX 802.11n20 Mode				
Test Channe	Frequency	Peak Conducted Output Power	Average Conducted Output Power	LIMIT
	(MHz)	(dBm)	(dBm)	dBm
CH01	2412	18.36	8.30	30
CH06	2437	18.34	8.50	30
CH11	2462	18.87	8.71	30

TX 802.11n40 Mode				
Test Channe	Frequency	Peak Conducted Output Power	Average Conducted Output Power	LIMIT
	(MHz)	(dBm)	(dBm)	dBm
CH03	2422	17.76	6.56	30
CH06	2437	17.86	6.68	30
CH09	2452	17.84	6.94	30



PCB Antenna

TX 802.11b Mode				
Test Channel	Frequency	Peak Conducted Output Power	Average Conducted Output Power	LIMIT
	(MHz)	(dBm)	(dBm)	dBm
CH01	2412	11.09	8.94	30
CH06	2437	11.26	9.18	30
CH11	2462	10.75	8.51	30

TX 802.11g Mode				
Test Channel	Frequency	Peak Conducted Output Power	Average Conducted Output Power	LIMIT
	(MHz)	(dBm)	(dBm)	dBm
CH01	2412	17.09	6.33	30
CH06	2437	16.74	6.74	30
CH11	2462	17.45	6.38	30

TX 802.11n20 Mode				
Test Channel	Frequency	Peak Conducted Output Power	Average Conducted Output Power	LIMIT
	(MHz)	(dBm)	(dBm)	dBm
CH01	2412	14.44	4.35	30
CH06	2437	14.86	4.70	30
CH11	2462	14.68	4.11	30

TX 802.11n40 Mode				
Test Channel	Frequency	Peak Conducted Output Power	Average Conducted Output Power	LIMIT
	(MHz)	(dBm)	(dBm)	dBm
CH03	2422	14.92	4.22	30
CH06	2437	15.07	4.33	30
CH09	2452	14.76	4.30	30



8. ANTENNA REQUIREMENT

8.1 STANDARD REQUIREMENT

15.203 requirement: For intentional device, according to 15.203: an intentional radiator shall be designed to ensure that no antenna other than that furnished by the responsible party shall be used with the device.

8.2 EUT ANTENNA

WizFi360-PA antenna is PCB Antenna, WizFi360-CON antenna is External Antenna. It comply with the standard requirement.





APPENDIX-PHOTOS OF TEST SETUP

Note: See test photos in setup photo document for the actual connections between Product and support equipment.

*****END OF THE REPORT*****

