



WM_W60X_Parameter Space Guide
V1.2

Beijing Winner Microelectronics Co., Ltd.

Address: 18th Floor, Yindu Building, No.67 Fucheng Road, Haidian District, Beijing, China

Tel: +86-10-62161900

Website: www.winnermicro.com

Document History

Version	Completion Date	Revision Record	Author	Auditor
1.0	2018/9/6	Innitial Release	Cuiych	
1.1	2018/10/12	Add figure number	Cuiych	
1.2	2018/12/15	Modify W600 to W60X	Cuiych	

Content

1	Introduction	3
1.1	Purpose	3
1.2	Readers	3
1.3	Abbreviations	3
1.4	Reference.....	3
2	QFLASH Space Management	4
2.1	Physical Layer Parameter Space	4
2.2	QFLASH Parameter Space.....	4
2.3	User Parameter Space.....	5
2.4	System Parameter Space	5
3	Physical Layer Parameter Space.....	6
3.1	Introduction of physical layer parameters	6
3.2	When to update physical parameters to W60X	6
3.3	How to use physical parameters	6
4	QFLASH Parameter Space	7
4.1	Introduction	7
4.2	When to update QFLASH parameters.....	7
4.2.1	How to use QFLASH parameter space.....	7
5	System Parameter Space.....	8
5.1	Introduction	8
5.2	How to user system parameters	8
5.2.1	Initialization Phase	8
5.2.2	Using Parameter Phase.....	10
6	User Parameter Space.....	11
6.1	User parameters	11
6.2	How to use user parameter space	11
6.2.1	The operation for user parameter space.....	11
6.2.2	Rules for adjusting user parameter space	11
6.2.3	Double backup mechanism.....	14

1 Introduction

1.1 Purpose

This document describes how to deal with QFLASH management, key parameter space, system parameter space and user parameter space.

1.2 Readers

For developers, testers and architects.

1.3 Abbreviations

No.	Abbreviations	Explain/Definition
1	QFLASH	Quad-SPI FLASH
2	SECBOOT	Second Boot, relative to ROM
3	ROM	Read-Only Memory

1.4 Reference

None

2 QFLASH Space Management

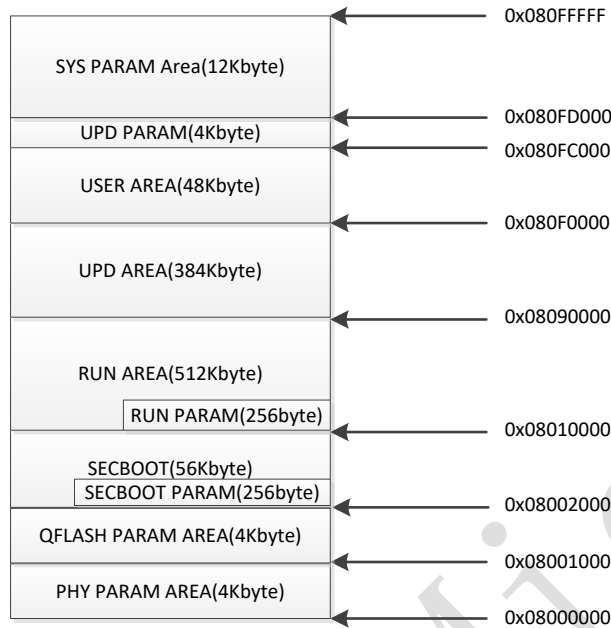

Figure 2-1

2.1 Physical Layer Parameter Space

Address Space: 0x8000000-0x8000FFF, size 4KByte

Parameter Content:

MAC address and RF parameters.

Parameters Arrangement:

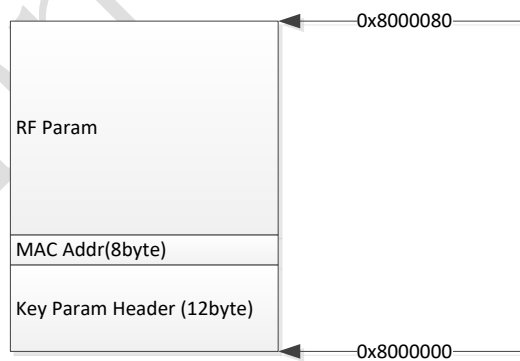

Figure 2-2

2.2 QFLASH Parameter Space

Address Space: 0x8001000-0x8001FFF, size 4KByte

Parameter Content:

QFLASH parameter header, Security Level, chip ID and QFLASH parameters.

Parameter Arrangement:

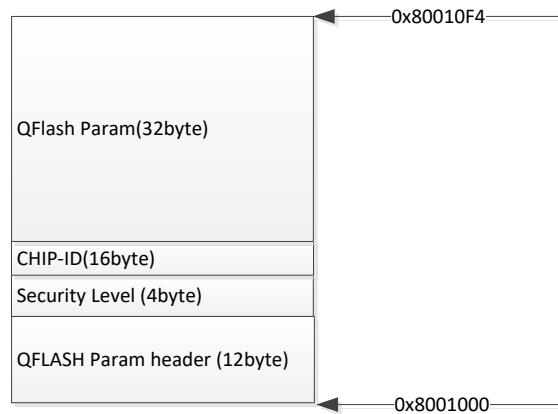

Figure 2-3

2.3 User Parameter Space

Address Space: 0x80F0000-0x80FBFFF, size 48KByte

Parameter Content:

User's self-defined parameters.

Parameter Arrangement:

Self-defined area by user.

2.4 System Parameter Space

Address Space: 0x80FD000-0x80FFFFFF, total 12KByte

Parameter Content:

Parameters used by run-time system.

Parameter Arrangement:

MAGIC Number:4byte	
PARTITION_NUM:2byte	MODIFY_CNT:2byte
RESERVED:4byte	
RESERVED:2byte	Length:2byte (size of total parameters, include CRC value)
Data Content ()	
CRC Value:4byte (the content value before CRC)	

- (1) 1st area of system parameter: 0x80FD000-0x80FDFFF
- (2) 2nd area of system parameter: 0x80FE000-0x80FEFFF
- (3) 3rd area of system parameter: 0x80FF000-0x80FFFFFF

3 Physical Layer Parameter Space

3.1 Introduction of physical layer parameters

Mac address, RF calibration parameters.

3.2 When to update physical parameters to W60X

During the W60X chipset or Wi-Fi module production

3.3 How to use physical parameters

When W60X starts up, the parameters will be read from key parameter space.

There is backup mechanism for physical layer parameters.

4 QFLASH Parameter Space

4.1 Introduction

Security level setting for W60X ROM, chipset's ID and QFLASH working parameters.

4.2 When to update QFLASH parameters

During W60X chipset production.

4.2.1 How to use QFLASH parameter space

For getting security level or chipset's ID or doing some operation to QFLASH after W60X starts up.

There is backup mechanism.

5 System Parameter Space

5.1 Introduction

System parameters include networking parameters, W60X hardware interface configuration parameters, working mode parameters and so on:

- (1) Related Wi-Fi (SSID, BSSID, Key, Channel list, PS mode flag, rate setting, region code, working mode)
- (2) IP information (static IP, DHCP enable flag, NTP server, DNS server)
- (3) Interface configuration (UART, SDIO, HSPI)
- (4) Other parameters (WEB)

5.2 How to use system parameters

5.2.1 Initialization Phase

There is a backup mechanism for system parameter space. One of the parameter spaces will be used by checksum value of CRC and MODIFY_CNT.

- (1) If CRC values of parameter spaces are both right, the bigger MODIFY_CNT's parameter space will be chosen.
- (2) If only one of CRC value is right, the right CRC's parameter space will be chosen, and the other space will be updated to current parameter value.
- (3) If neither CRC values are right, first step is to try to recover the parameters. If the attempt is fail, the default parameters should be used for system running, and then update the default parameter values to parameter space.

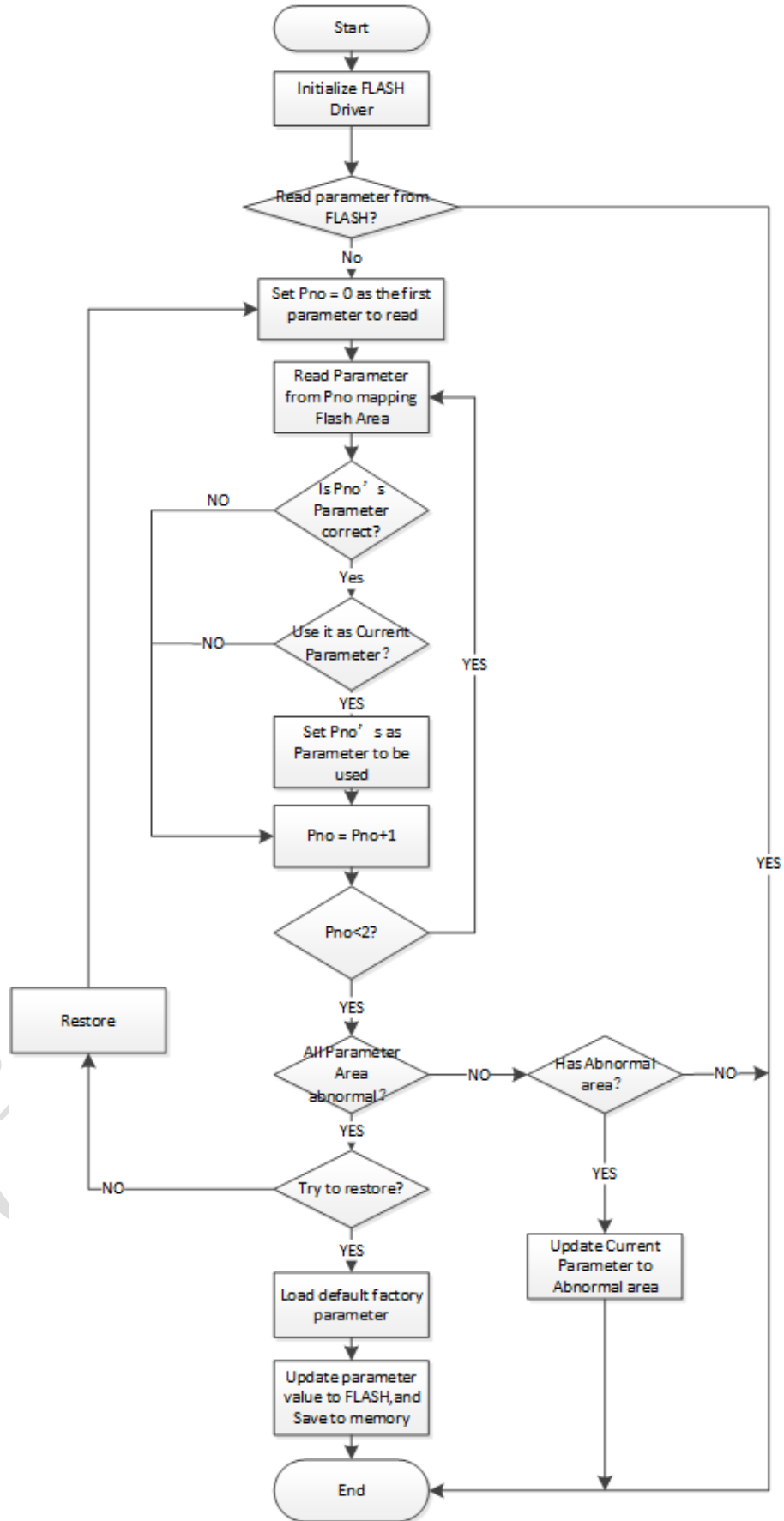

Figure 5-1

5.2.2 Using Parameter Phase

(1) Obtain Parameters

Besides the system parameters are saved in 2 areas of QFLASH, such parameters are also be backed up into RAM during system initialization. This can reduce frequent access to QFLASH.

(2) When to Update Parameters

1) During system starts up, the parameter space will be updated because of first time startup or parameters destroyed.

2) During system running, the parameter space will be updated when the system parameters value are modified.

6 User Parameter Space

6.1 User parameters

Self-defined parameters or running logs which are requested to be saved by W60X user.

6.2 How to use user parameter space

6.2.1 The operation for user parameter space

W60X SDK provides APIs for operating user parameter space. These APIs can ensure that user can only use relative address to operate to the parameter space (relative to USER_ADDR_START).

6.2.2 Rules for adjusting user parameter space

The default size of user parameter space is 48KByte. This size is defined according to the max size of code area.

6.2.2.1 How to adjust user parameter space

(1) Based on WM_W600_SEC.img's area which user compiled out.

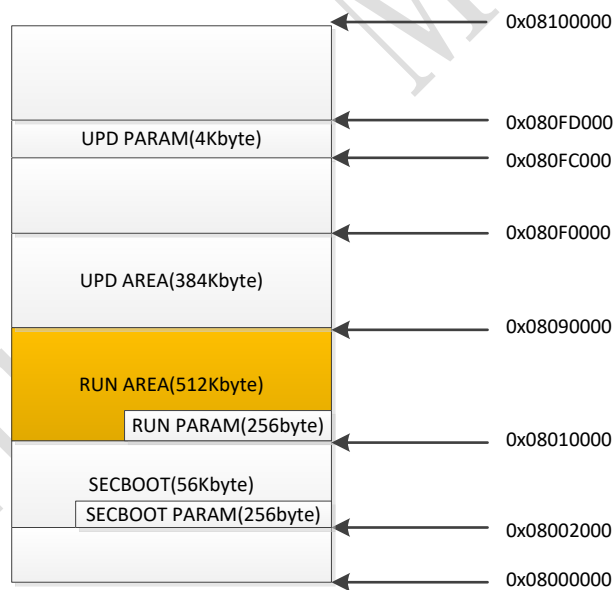

Figure 6-1

(2) Based on updating area of WM_W600_GZ.img.

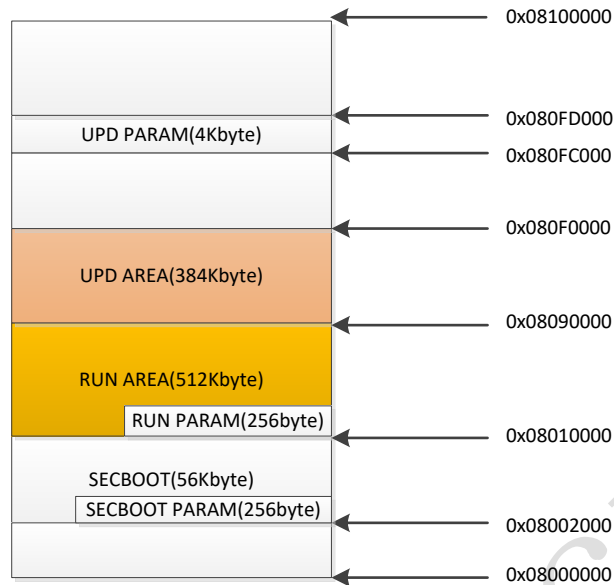

Figure 6-2

(3) (Please pay attention to) Based on the size of WM_W600_SEC.img and WM_W600_GZ.img to confirm an address which is the beginning of QFLASH BLOCK (64KByte).

(4) Redefine the start address of user space based on the former result of IMAGE size.

(5) Modify the W60X SDK's macro definition value of user space based on former address value.

```

/**Upgrade image header area & System parameter area */
#define CODE_UPD_HEADER_ADDR (FLASH_BASE_ADDR + 0xFC000)
#define TLS_FLASH_PARAM1_ADDR (FLASH_BASE_ADDR + 0xFD000)
#define TLS_FLASH_PARAM2_ADDR (FLASH_BASE_ADDR + 0xFE000)
#define TLS_FLASH_PARAM_RESTORE_ADDR (FLASH_BASE_ADDR + 0xFF000)
#define TLS_FLASH_END_ADDR (FLASH_BASE_ADDR + 0xFFFFF)

#define FLASH_KEY_PARAM_AREA_LEN (0x2000)

#define SECBOOT_HEADER_ADDR (FLASH_BASE_ADDR + FLASH_KEY_PARAM_AREA_LEN)
#define SECBOOT_HEADER_AREA_LEN (0x100)

#define SECBOOT_AREA_ADDR (SECBOOT_HEADER_ADDR + SECBOOT_HEADER_AREA_LEN)
#define SECBOOT_AREA_LEN (0x10000 - FLASH_KEY_PARAM_AREA_LEN - SECBOOT_HEADER_AREA_LEN)

/**Run-time image header area*/
#define CODE_RUN_HEADER_ADDR (SECBOOT_AREA_ADDR + SECBOOT_AREA_LEN)
#define CODE_RUN_HEADER_AREA_LEN (0x100)

/**Run-time image area*/
#define CODE_RUN_START_ADDR (CODE_RUN_HEADER_ADDR + CODE_RUN_HEADER_AREA_LEN)
#define CODE_RUN_AREA_LEN (512*1024 - CODE_RUN_HEADER_AREA_LEN)

/**Upgrade image area*/
#define CODE_UPD_START_ADDR (CODE_RUN_START_ADDR + CODE_RUN_AREA_LEN)
#define CODE_UPD_AREA_LEN (384*1024)

/**Area can be used by User*/
#define USER_ADDR_START (CODE_UPD_START_ADDR + CODE_UPD_AREA_LEN)
#define TLS_FLASH_PARAM_DEFAULT (USER_ADDR_START)
#define USER_AREA_LEN (CODE_UPD_HEADER_ADDR - USER_ADDR_START)

```

(6) Adjust the parameters for generating IMAGE based on the new starting address of updating space. (see the red words)

```

wm_gzip.exe "..\Bin\WM_W600.bin"

makeimg.exe "..\Bin\WM_W600.bin.gz" "..\Bin\WM_W600_GZ.img" 0 1 "..\Bin\version.txt" 90000 10100 "..\Bin\WM_W600.bin"

makeimg.exe "..\Bin\WM_W600.bin" "..\Bin\WM_W600_SEC.img" 0 0 "..\Bin\version.txt" 90000 10100

makeimg.exe "..\Bin\WM_W600.bin" "..\Bin\WM_W600.img" 0 0 "..\Bin\version.txt" 90000 10100

makeimg_all.exe "..\Bin\secboot.img" "..\Bin\WM_W600.img" "..\Bin\WM_W600.FLS"

```

6.2.2.2 Example

Following is the size of user IMAGE after compiling:

WM_W600_SEC.img: 311Kbyte

WM_W600_GZ.img: 222Kbyte

Calculate a value which is integral multiple of 64KByte based on IMAGE size.

Running Space: 320Kbyte

Updating Space: 256Kbyte

Following is the steps of configuration:

(1) New space of user area is in the yellow box

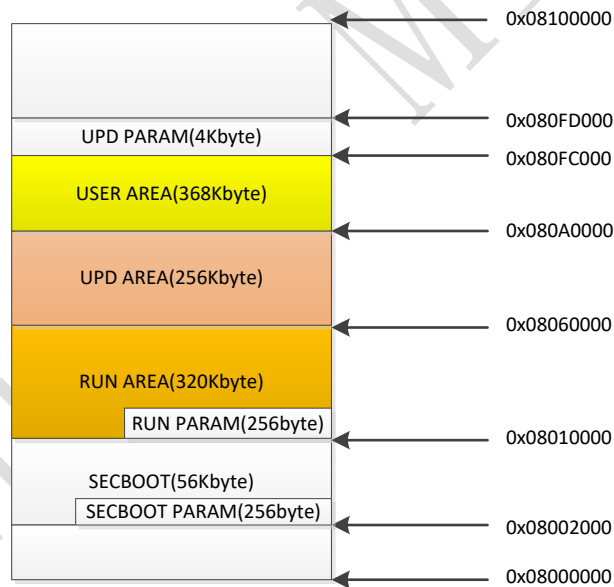

Figure 6-3

(2) Adjust new code area:

```

#define SECBOOT_HEADER_ADDR      (FLASH_BASE_ADDR + FLASH_KEY_PARAM_AREA_LEN)
#define SECBOOT_HEADER_AREA_LEN  (0x100)

#define SECBOOT_AREA_ADDR        (SECBOOT_HEADER_ADDR + SECBOOT_HEADER_AREA_LEN)
#define SECBOOT_AREA_LEN        (0x10000 - FLASH_KEY_PARAM_AREA_LEN - SECBOOT_HEADER_AREA_LEN)

/**Run-time image header area*/
#define CODE_RUN_HEADER_ADDR      (SECBOOT_AREA_ADDR + SECBOOT_AREA_LEN)
#define CODE_RUN_HEADER_AREA_LEN  (0x100)

/**Run-time image area*/
#define CODE_RUN_START_ADDR        (CODE_RUN_HEADER_ADDR + CODE_RUN_HEADER_AREA_LEN)
#define CODE_RUN_AREA_LEN          (320*1024 - CODE_RUN_HEADER_AREA_LEN)

/**Upgrade image area*/
#define CODE_UPD_START_ADDR        (CODE_RUN_START_ADDR + CODE_RUN_AREA_LEN)
#define CODE_UPD_AREA_LEN          (256*1024)

/**Area can be used by User*/
#define USER_ADDR_START            (CODE_UPD_START_ADDR + CODE_UPD_AREA_LEN)
#define TLS_FLASH_PARAM_DEFAULT    (USER_ADDR_START)
#define USER_AREA_LEN              (CODE_UPD_HEADER_ADDR - USER_ADDR_START)

```

(3) Modify IMAGE generation address:

```
wm_gzip.exe "..\Bin\WM_W600.bin"
```

```
makeimg.exe "..\Bin\WM_W600.bin.gz" "..\Bin\WM_W600_GZ.img" 0 1 "..\Bin\version.txt" 60000 10100 "..\Bin\WM_W600.bin"
```

```
makeimg.exe "..\Bin\WM_W600.bin" "..\Bin\WM_W600_SEC.img" 0 0 "..\Bin\version.txt" 60000 10100
```

```
makeimg.exe "..\Bin\WM_W600.bin" "..\Bin\WM_W600.img" 0 0 "..\Bin\version.txt" 60000 10100
```

```
makeimg_all.exe "..\Bin\secboot.img" "..\Bin\WM_W600.img" "..\Bin\WM_W600.FLS"
```

(4) Generate a new WM_W600_GZ.img, after reset W60X, the new address of user parameter space will be set.

6.2.3 Double backup mechanism

If user has very important data which should be saved in QFLASH, the double backup mechanism is suggested. The main area and backup area should be divided according to 4Kbyte sector.