

Test Report

1. Client

- Name : WIZNET Co., Ltd.
- Address : 5F Humax Village, 216, Hwangsaeul-ro, Bundang-gu, Seongnam-si, Gyeonggi-do, Republic of Korea

2. Use of Report : FCC SDoC, IC

3. Sample Description :

- Model W5100S-EVB-Pico
- Kind of Product iEthernet Module
- Variant Model Name -

4. Date of Receipt : 2023.08.25

5. Date of Test : 2023. 09. 13 ~ 2023. 09. 22



6. Test Method : FCC part 15 subpart B, Class A / ICES-003

7. Test Results : Complied

This test report must not be reproduced or reproduced in any way.

The results shown in this test report are the results of testing the samples provided.

This test report is prepared according to the requirements of ISO / IEC 17025.

Affirmation	Tested by	Technical Manager
	DONG YONG, LEE  (signature)	YONG MIN, PARK  (signature)

09 25, 2023

EMC Labs Co., Ltd.



[Contents]

1. Laboratory Information	3
2. Equipment Under Test	4
2.1 General Information	4
2.2 Configuration of the equipment under test	4
2.3 EUT Description	5
2.4 Operating Conditions	5
2.5 The drawing of general test setup	5
3. Summary	6
3.1 Modification to the E.U.T.....	6
3.2 Standards & results.....	6
4. Test results.....	7
4.1 Radiated emission	7
4.2 Conducted Emission	13
5. Test photographs	16
6. E.U.T. photographs.....	19

1. Laboratory Information

Address

EMC Labs Co., Ltd.

Laboratory : 100, Jangjateo-ro, Hobeop-myeon, Icheon-si, Gyeonggi-do, 17396, Korea

Telephone Number : +82-31-637-8895

Facsimile Number : +82-505-116-8895

SITE MAP



2. Equipment Under Test

2.1 General Information

- Table-Top
 Floor – Standing
 Table-Top & Floor-Standing (combination)

2.2 Configuration of the equipment under test

Equipment	Model	Manufacturer	Serial No.
NOTE PC	82KD000UKR	LENOVO	AAN0AS752350448
Adapter	ADLX65CLGR2A	Lite-On Technology Corp.	83LW0AK085Y

Type	Description	Connection	Spec.	Length (m)
EUT	DC IN	NOTE PC	Shield	0.8
	LAN	NOTE PC	Unshield	5.0

2.3 EUT Description

The following features describe EUT represented by this report

Test Voltage : AC 120 V / 60 Hz

EUT Highest operating frequency: 108 MHz

Model Name: CARINA

2.4 Operating Conditions

The equipment under test was operated during the measurement under following

Test mode	Normal Operating
1	Connect the EUT to the NOTE PC and proceed with the test by checking operation through the 'AX1' program provided by the company.

2.5 The drawing of general test setup

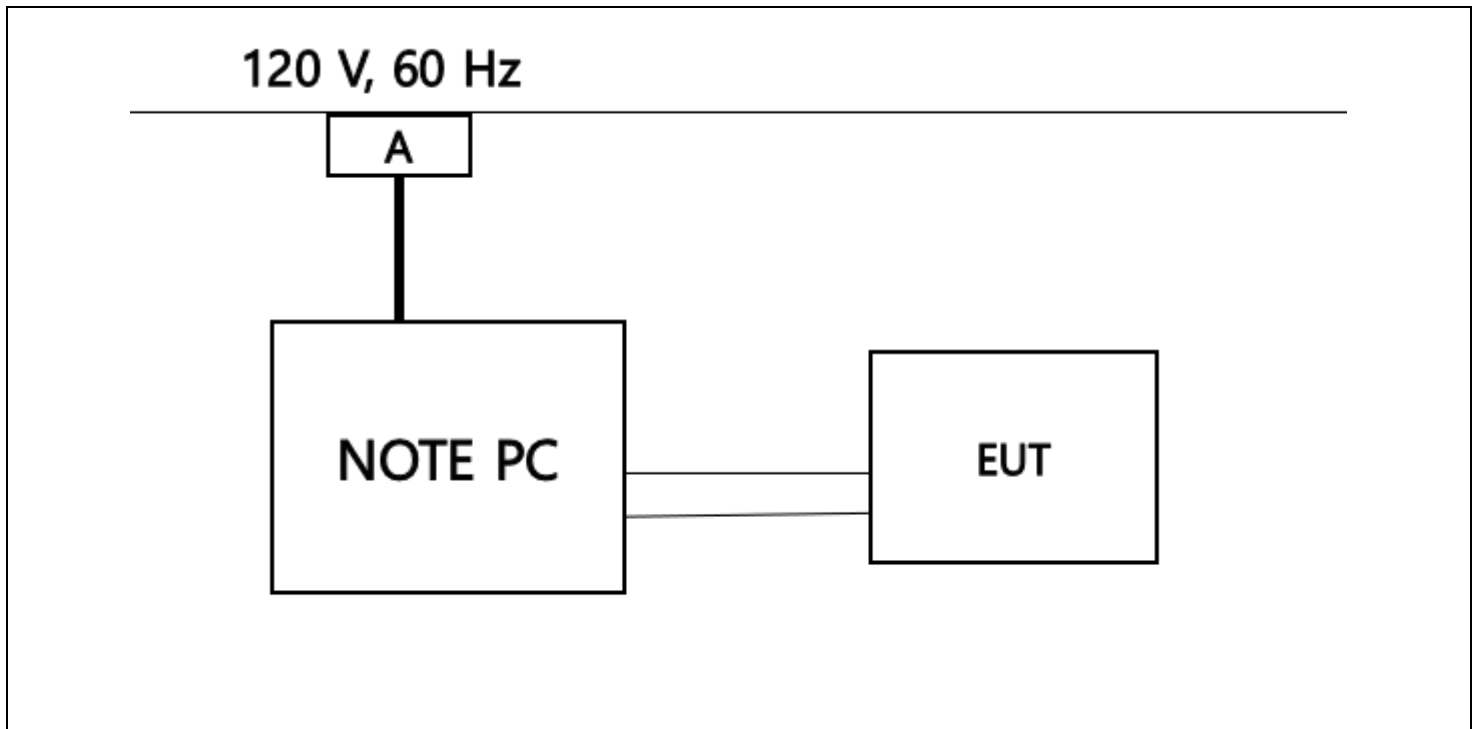

3. Summary

In the above configuration tested, The EUT complied with the requirement of the specification

3.1 Modification to the E.U.T.

- No modifications to the EUT were necessary to comply.

3.2 Standards & results

FCC Part 15 Subpart B (Class A)

ANSI C63.4 – 2014, ANSI C63.4a – 2017

Test items	Test method	Result
Radiated Emission	FCC part 15 subpart B ANSI C63.4 – 2014 ANSI C63.4a – 2017	Pass
Conducted Emission	FCC part 15 subpart B ANSI C63.4 – 2014 ANSI C63.4a – 2017	Pass

4. Test results

4.1 Radiated emission

Environmental Conditions

Temperature	(23.0 °C) - Semi anechoic chamber (10m) (23.1 °C) - Fully anechoic chamber(3m)
Humidity	(50 % R.H.) - Semi anechoic chamber (10m) (49 % R.H.) - Fully anechoic chamber(3m)
Test Area	Semi anechoic chamber (10m) – Below 1GHz Fully anechoic chamber(3m) – Above 1GHz
Test date	2023.09.13 - Semi anechoic chamber (10m) 2023.09.22 - Fully anechoic chamber(3m)

4.1.1 Measurement procedure

The test was done at a 10 m fully anechoic chamber test site with a quasi-peak detector.

EUT was placed on a non-metallic table height of 0.8 m above the reference ground plane.

They were folded back and forth forming a bundle 0.3 m to 0.4 m long and were hanged at a 0.4 m height to the ground plane.

Cables connected to EUT were fixed to cause maximum emission.

Test was made with the antenna positioned in both the horizontal and vertical planes of polarization.

The measurement antenna was varied in height above the conducting ground plane to obtain the maximum signal strength.

4.1.2 Used equipments

[Below 1GHz]

Equipment	Model no	Manufacturer	Serial no.	Next cal. date	Used
MEASUREMENT SOFTWARE	EMC32 VER 10.60.15	Rohde&Schwarz	-	-	<input type="checkbox"/>
Spectrum Analyzer	E4401B	HP.Agilent	US39440387	2024.06.27	<input checked="" type="checkbox"/>
EMI TEST RECEIVER	ESVS10	ROHDE&SCHWARZ	846285/004	2024.06.27	<input checked="" type="checkbox"/>
Controllers	CO3000-4port	Innco Systems GmbHRE	CO3000/ 1060/42111117/P	-	<input checked="" type="checkbox"/>
Antenna Masts	MA4640/800-XP-ET	Innco Systems GmbHRE	-	-	<input checked="" type="checkbox"/>
Turn tables	DS3000-S-1t	Innco Systems GmbHRE	-	-	<input checked="" type="checkbox"/>
AMPLIFIER	310N	SONOMA INSTRUMENT	185757	2023.08.30	<input checked="" type="checkbox"/>
Bi-Log Ant	VULB9168	Schwarzbeck	902	2023.11.30	<input checked="" type="checkbox"/>

[Above 1GHz]

Equipment	Model no	Manufacturer	Serial no.	Next cal. date	Used
MEASUREMENT SOFTWARE	EMC32 VER 10.60.15	Rohde&Schwarz	-	-	<input checked="" type="checkbox"/>
EMI TEST RECEIVER	ESW44	Rohde&Schwarz	101952	2024.03.14	<input checked="" type="checkbox"/>
Controllers	CO3000-4port	Innco Systems GmbHRE	CO3000/ 1061/ 42111117/P	-	<input checked="" type="checkbox"/>
Antenna Masts	MA4640/800-XP-ET	Innco Systems GmbHRE	-	-	<input checked="" type="checkbox"/>
Turn tables	DS2000-S-1t	Innco Systems GmbHRE	-	-	<input checked="" type="checkbox"/>
Horn ANT	BBHA9120D	Schwarzbeck	974	2023.11.29	<input checked="" type="checkbox"/>
Amplifier	TK-PA18H	TESTEK	220104-L	2024.03.14	<input checked="" type="checkbox"/>

4.1.3 Test data

* Receiving Antenna Mode : Horizontal, Vertical

* 10 m Chamber

* Note : Reading = Test Receiver meter,

Pol.= Polarization → H = Horizontal, V = Vertical

Result [dB(μ V/m)] = Reading [dB(μ V)] + Antenna factor [dB/m] + Cable Loss [dB] – Amp Gain [dB]

If, in accordance with §15.33 of this part, measurements must be performed above 1000 MHz, compliance above 1000 MHz shall be demonstrated with the emission limit in paragraph (a) or (b) of this section, as appropriate. Measurements above 1000 MHz may be performed at the distance specified in the CISPR 32 publications for measurements below 1000 MHz provided the limits in paragraphs (a) and (b) of this section are extrapolated to the new measurement distance using an inverse linear distance extrapolation factor (20 dB/decade)

4.1.4 Test Result

[Below 1GHz]

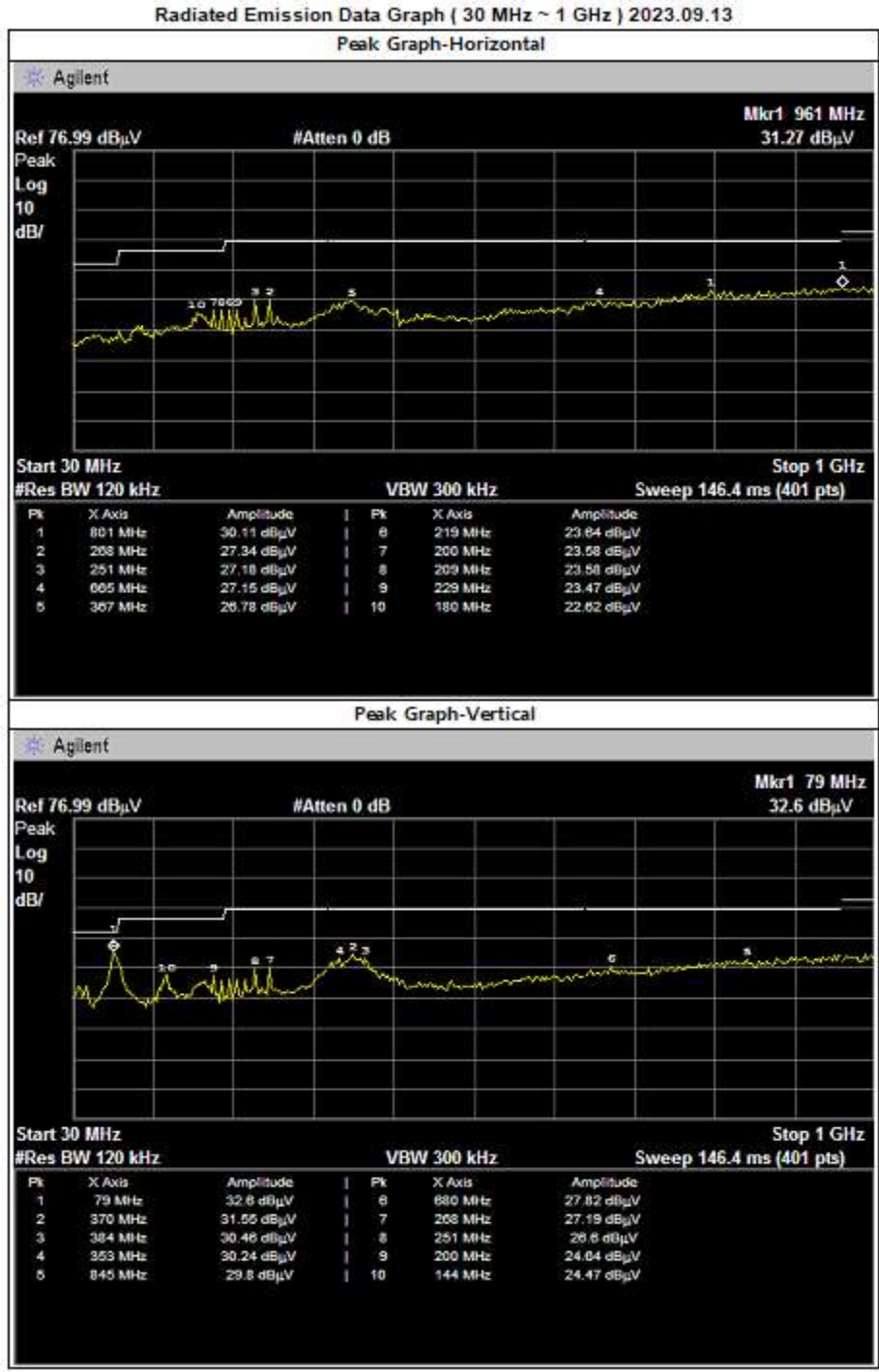

***10m Chamber Scan Data**

제품명 : iEthernet Module
 모델명 : W5100S-EVB-Pico
 제조사 : WIZNET Co., Ltd

측정일 : 2023.09.13
 모 드 : Operation

A

Frequency [MHz]	Total Reading [dB μ V/m]	Pol.	Height [m]	angle [°]	Quasi-Peak [dB μ V/m]	Correction			Limits [dB μ V/m]	Result [dB μ V/m]	Margin [dB]
						Antenna [dB/m]	Cable [dB]	Amp Gain [dB]			
79.15	58.80	V	1.0	200	(26,18)	9,10	4,36	39,64	39,0	32,62	6,38
353.97	45.70	V	1.0	120	(15,54)	14,30	9,55	39,39	46,4	30,16	16,24
370.25	46.20	V	1.1	360	(14,61)	15,00	9,82	39,43	46,4	31,59	14,81
384.54	44.30	V	1.1	90	(13,95)	15,48	10,04	39,47	46,4	30,35	16,05
801.66	28.10	H	4.0	45	2,03	22,40	15,01	35,38	46,4	30,13	16,27
845.85	28.20	V	1.1	30	1,63	22,50	15,44	36,31	46,4	29,83	16,57

[Above 1GHz]

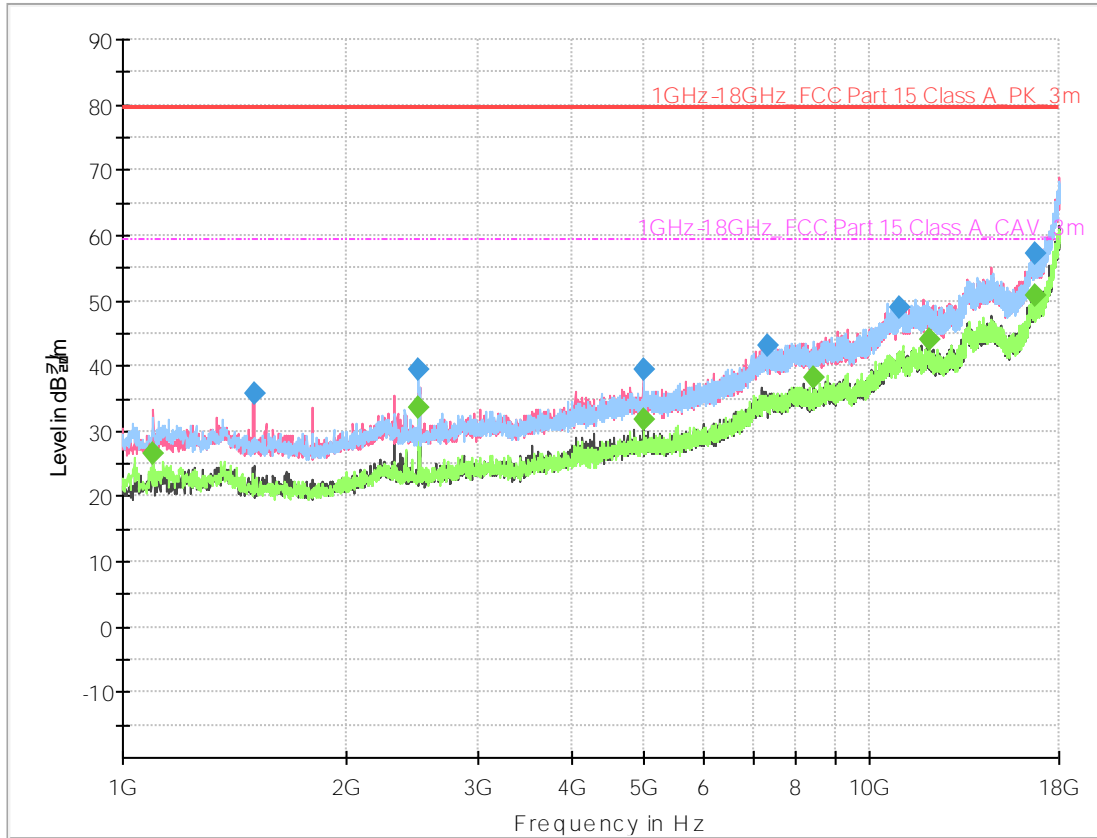

Final_Result

Frequency	MaxPeak (dBµV/m)	Average (dBµV/m)	Limit (dBµV/m)	Margin (dB)	Bandwidth	Height (cm)	Pol	Azimuth	Corr. (dB/m)
1098.60	---	26.58	60	32.92	1000	100	H	157	-16.8
1498.10	35.76	---	80	43.74	1000	100	V	216	-15.6
2490.90	---	33.56	60	25.94	1000	100	H	25	-12.0
2490.90	39.44	---	80	40.06	1000	100	H	25	-12.0
4981.40	---	31.75	60	27.75	1000	100	V	66	-1.5
4988.20	39.43	---	80	40.07	1000	100	V	55	-1.4
7313.80	43.17	---	80	36.33	1000	100	V	180	6.6
8430.70	---	38.10	60	21.40	1000	100	V	150	6.3
11009.60	49.04	---	80	30.46	1000	100	H	276	14.2
12026.20	---	44.03	60	15.47	1000	100	H	209	13.6
16674.00	57.32	---	80	22.18	1000	100	H	342	21.0
16740.30	---	50.83	60	8.67	1000	100	V	314	21.4

* Test Result

Complied

Not complied

4.2 Conducted Emission

Environmental Conditions

Temperature	(23.1 °C)
Humidity	(50 % R.H.)
Test Area	Conducted Room
Test date	2023.09.13

4.2.1 Limits of conducted emission measurement

Frequency [MHz]	Class A (dBuV)		Class B (dBuV)	
	Quasi-peak	Average	Quasi-peak	Average
0.15 - 0.5	79	66	66-56 *	58-46*
0.5 - 5	73	60	56	46
5 - 30	73	60	60	50

*The limit decreases linearly with the logarithm of frequency.

4.2.2 Measurement procedure

Mains

The measurements were performed in a shielded room. EUT was placed on a non-metallic table height of 0.8 m above the reference ground plane. The rear of table was located 0.4 m to the vertical conducted plane. EUT was power through the LISN, which was bonded to the ground plane. The LISN power was filtered. Each EUT power lead, except ground (safety) lead, was individually connected through a LISN to input power source. All I.O cables are positioned to simulate typical actual usage according to the test standard. Both lines of power cord, hot and neutral, were measured.

4.2.3 Used equipments

Equipment	Model	Manufacturer	Serial or Firmware (No./Ver.)	Next Cal. Date	Used
MEASUREMENT SOFTWARE	EMC32 VER 10.60.15	Rohde&Schwarz	-	-	<input checked="" type="checkbox"/>
Test Receiver	ESR7	Rohde&Schwarz	101616	2024.06.27	<input checked="" type="checkbox"/>
※LISN	ENV216	Rohde&Schwarz	100409	2024.01.09	<input checked="" type="checkbox"/>
LISN	3825-2	EMCO	8901-1458	2024.01.09	<input type="checkbox"/>
PULSE LIMITER	EPL-30	lignex1	-	2024.01.09	<input checked="" type="checkbox"/>

4.2.4 Test data

• Note. QP = Quasi-Peak, AV= Average , • Loss = LISN Loss + Cable Loss, • Measurement time : 1 s

4.2.5 Test Result

[HOT] – [Multi Tap]

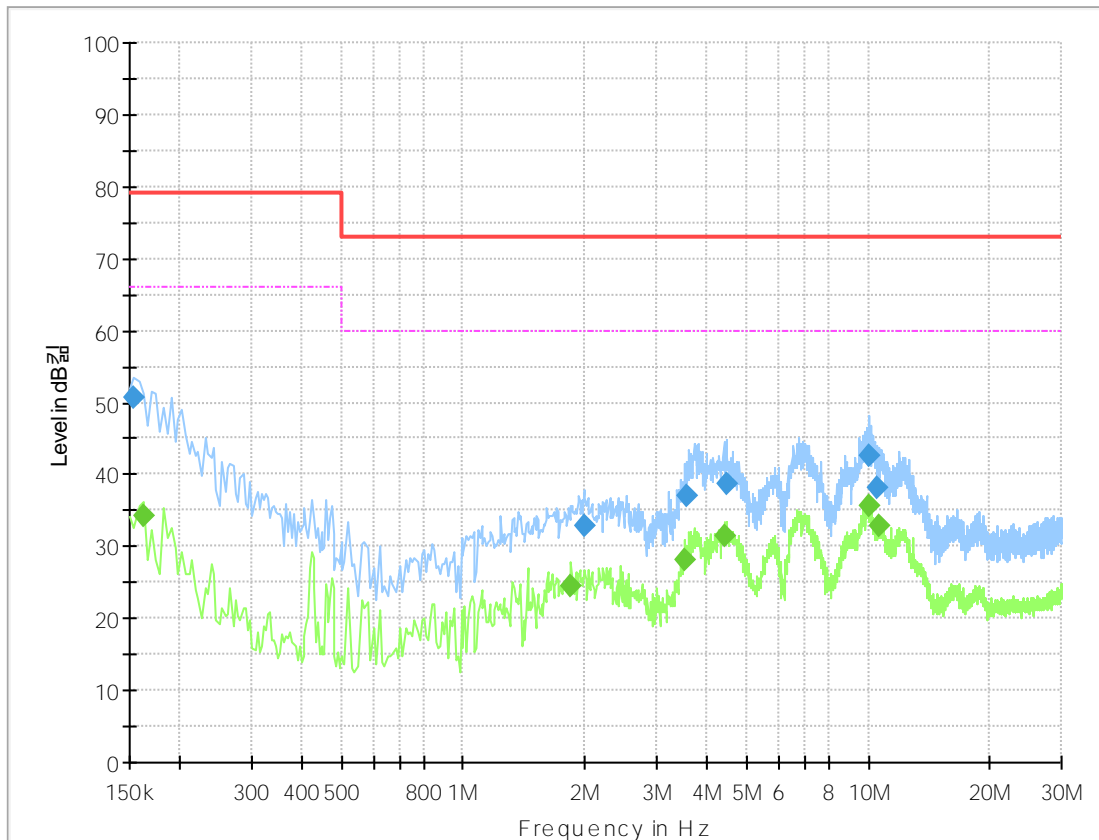

Final_Result

Frequency (MHz)	QuasiPeak (dBµV)	CAverage (dBµV)	Limit (dBµV)	Margin (dB)	Bandwidth (kHz)	Line	Corr. (dB)
0.154	50.69	---	79.00	28.31	9	L1	20.0
0.162	---	34.30	66.00	31.70	9	L1	20.1
1.850	---	24.41	60.00	35.59	9	L1	20.5
1.990	32.77	---	73.00	40.23	9	L1	20.6
3.530	---	28.25	60.00	31.75	9	L1	20.9
3.570	36.93	---	73.00	36.07	9	L1	20.9
4.440	---	31.39	60.00	28.61	9	L1	21.2
4.480	38.69	---	73.00	34.31	9	L1	21.2
10.030	42.48	---	73.00	30.52	9	L1	23.2
10.070	---	35.56	60.00	24.44	9	L1	23.3
10.460	38.18	---	73.00	34.82	9	L1	23.4
10.650	---	32.82	60.00	27.18	9	L1	23.4

[NEUTRAL] – [Multi Tap]

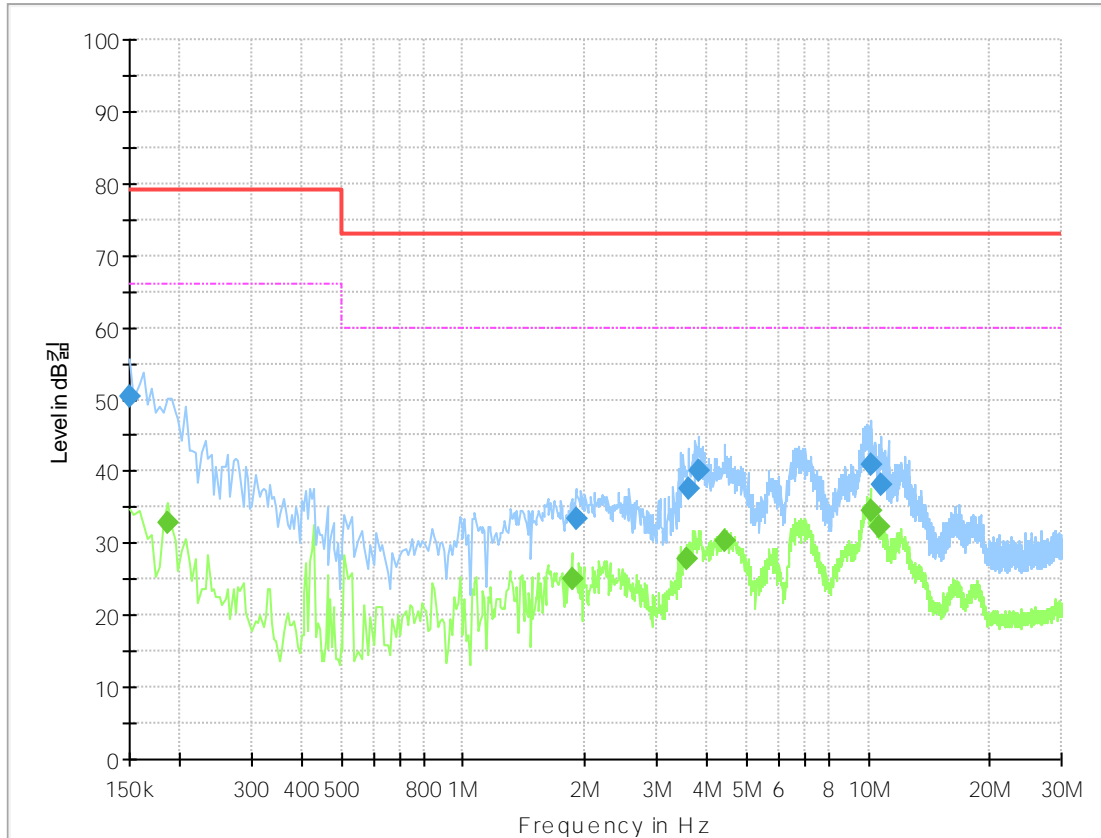

Final_Result

Frequency (MHz)	QuasiPeak (dBµV)	CAverage (dBµV)	Limit (dBµV)	Margin (dB)	Bandwidth (kHz)	Line	Corr. (dB)
0.150	50.41	---	79.00	28.59	9	N	19.9
0.186	---	32.74	66.00	33.26	9	N	19.8
1.860	---	25.12	60.00	34.88	9	N	20.0
1.900	33.38	---	73.00	39.62	9	N	20.0
3.570	---	27.96	60.00	32.04	9	N	20.1
3.600	37.71	---	73.00	35.29	9	N	20.1
3.810	40.04	---	73.00	32.96	9	N	20.2
4.410	---	30.34	60.00	29.66	9	N	20.3
10.110	---	34.64	60.00	25.36	9	N	21.6
10.120	40.98	---	73.00	32.02	9	N	21.6
10.650	---	32.39	60.00	27.61	9	N	21.8
10.750	38.07	---	73.00	34.93	9	N	21.8

* Test Result

Complied

Not complied

5. Test photographs

Radiated Emission (Below 1GHz)

[Front]

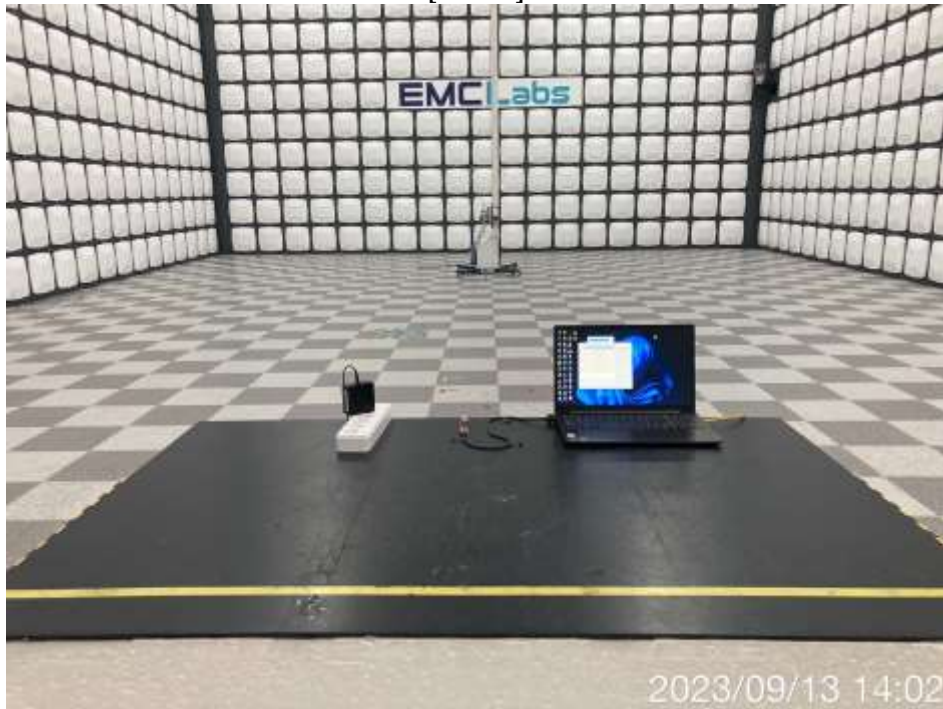

[Rear]



Radiated Emission (Above 1GHz)

[Front]



[Rear]

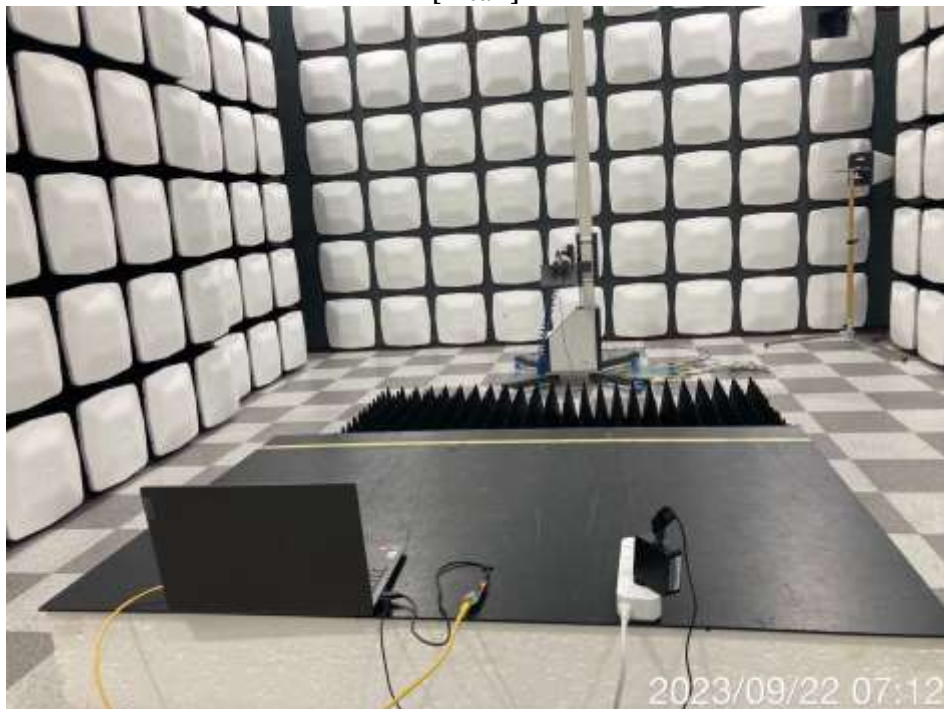

Conducted Emission (Main Power)

[Front]



[Rear]



6. E.U.T. photographs

[Front View]



[Rear View]

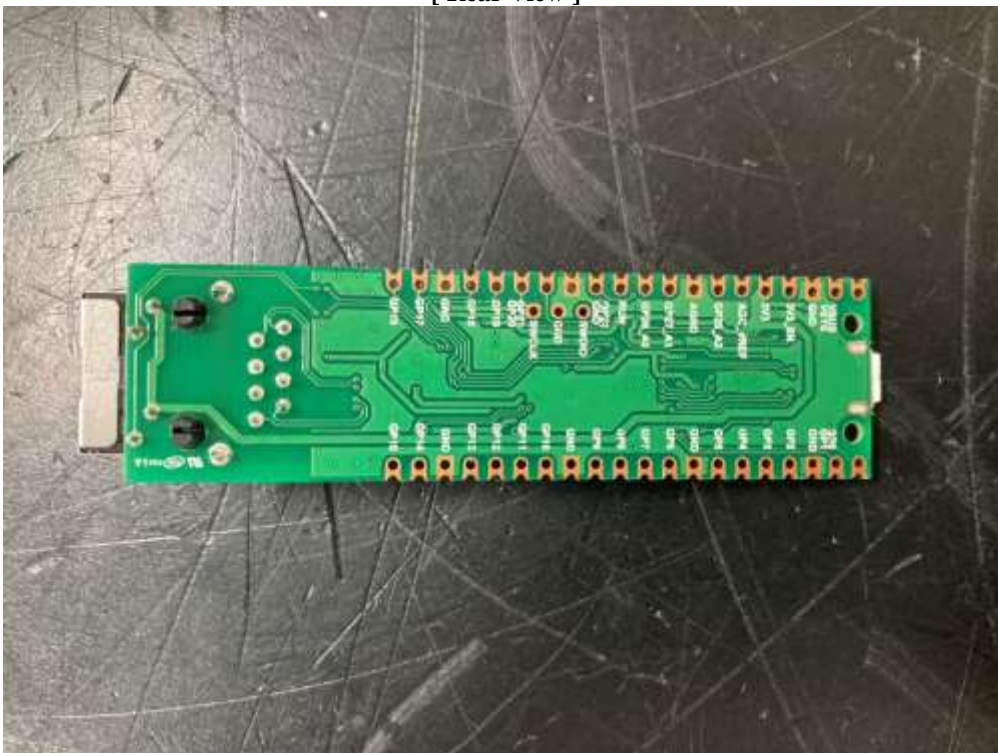

[Port#1_View]

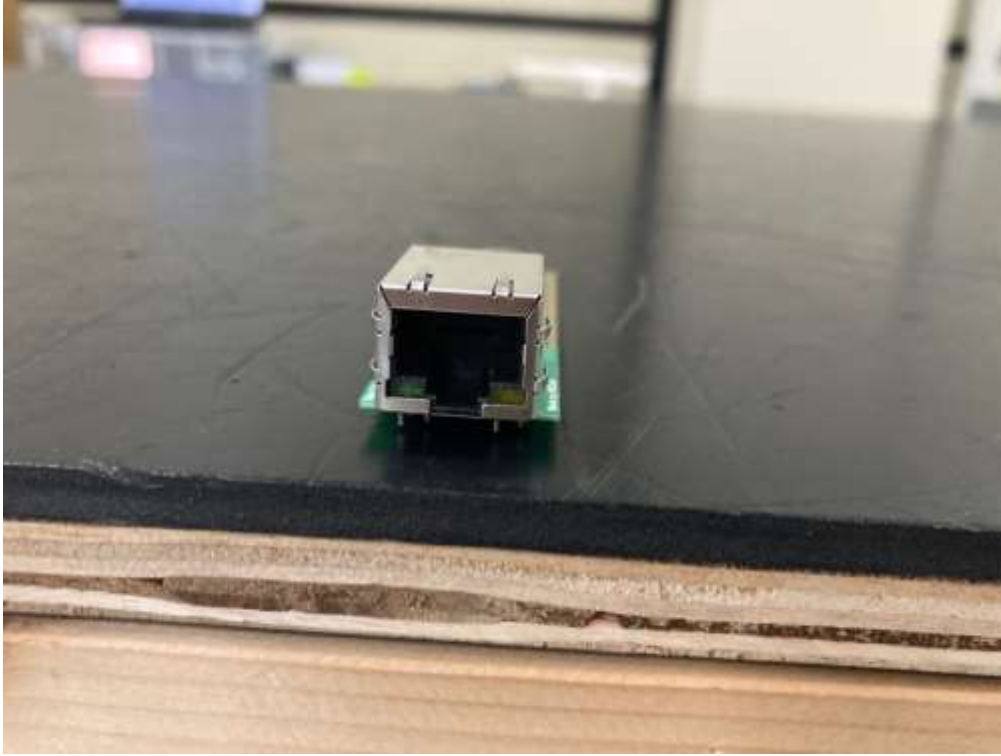

[Port#2_View]

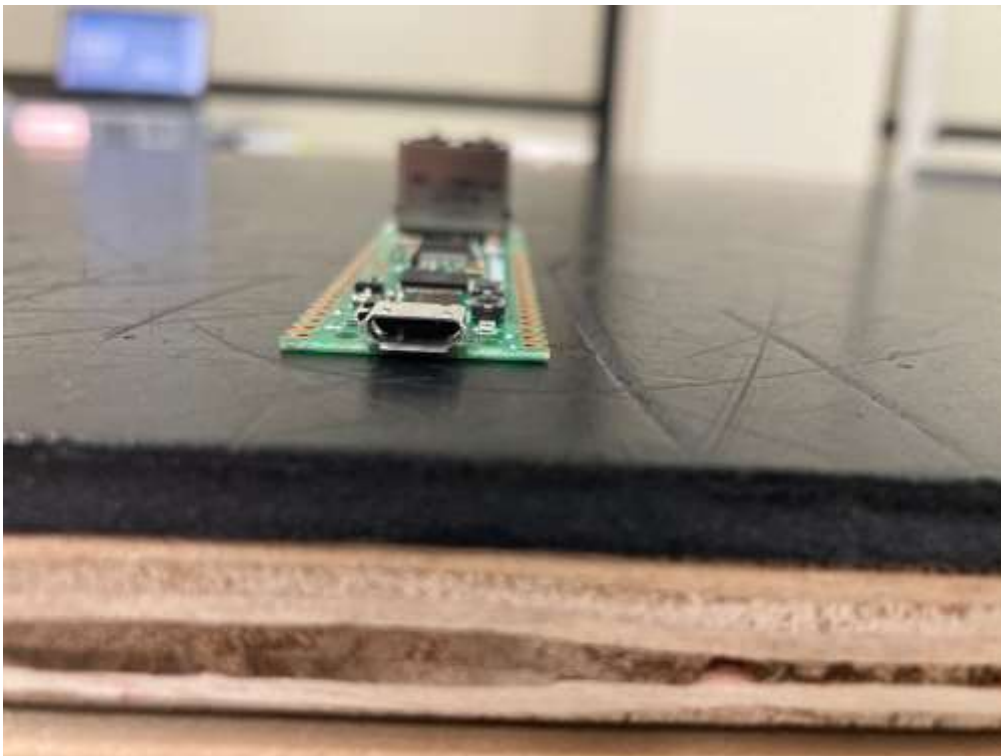

-THE END-