

Test Report

1. Client

- Name : WIZNET Co., Ltd.
- Address : 5F Humax Village, 216, Hwangsaoul-ro, Bundang-gu, Seongnam-si, Gyeonggi-do, Republic of Korea

2. Use of Report : CE DoC

3. Sample Description :

- Model W5100S-EVB-Pico
- Kind of Product iEthernet Module
- Variant Model Name -



4. Date of Receipt : 2023.08.23

5. Date of Test : 2023. 09. 12 ~ 2023. 09. 17

6. Test Method : EN 55032:2015/A11:2020, CLASS A
 EN 55035:2017/A11:2020
 EN 61000-3-2:2019/A1:2021
 EN 61000-3-3:2013/A1:2019

7. Test Results : Complied

This test report must not be reproduced or reproduced in any way.
 The results shown in this test report are the results of testing the samples provided.
 This test report is prepared according to the requirements of ISO / IEC 17025.

Affirmation	Tested by	Technical Manager
	DongYong, Lee  (signature)	YONG MIN, PARK  (signature)

10 18, 2023

EMC Labs Co., Ltd.



[Contents]

1. Revision history	3
2. Test Regulation	4
3. Laboratory Information	5
4. Equipment Under Test	6
4.1 Product Specification	6
4.2 EUT Modification	6
4.3 General Information.....	7
4.4 Configuration of the equipment under test.....	7
4.5 Operating Conditions	8
4.6 The drawing of general test setup.....	8
5. Summary of Test Result	9
5.1 Summary of EMI emission test result	9
5.2 Summary of immunity test result	9
5.3 Performance criteria.....	10
6. Test Results	11
6.1 Conducted Emission	11
6.2 Conducted Emission(Telecommunications/network).....	15
6.3 Radiated emission.....	17
6.4 Electrostatic Discharge.....	23
6.5 Radio Frequency Electromagnetic Fields	27
6.6 Electric Fast Transient/BURST.....	30
6.7 Surge	32
6.8 Conducted Immunity	34
6.9 Magnetic field Immunity	36
6.10 Dips and Interruptions	38
6.11 Harmonics	40
6.12 Flicker	42
7. Test Photographs	44
8. E.U.T. Photographs	54

1. Revision history

Issued report No.	Version	Issued date	Revisions
KR0140-EC2310-001	Rev.00	October 18, 2023	Original

2. Test Regulation

Emission : EN 55032:2015/A11:2020

EN 55032 : 2015/A11:2020

Class B Equipment

Class A Equipment

Generic

EN 61000-3-2 : 2019/A1:2021

EN 61000-3-3 : 2013/A1:2019

Immunity : EN 55035:2017/A11:2020

EN 61000-4-2 : 2009

EN 61000-4-3 : 2006/A2:2010

EN 61000-4-4 : 2012

EN 61000-4-5 : 2006

EN 61000-4-6 : 2009

EN 61000-4-8 : 2010

EN 61000-4-11 : 2004

3. Laboratory Information

Address

EMC Labs Co., Ltd.

Laboratory : 100, Jangjateo-ro, Hobeop-myeon, Icheon-si, Gyeonggi-do, 17396, Korea
Telephone Number : +82-31-637-8895
Facsimile Number : +82-505-116-8895

SITE MAP



4. Equipment Under Test

4.1 Product Specification

Test Voltage : AC 120 V / 60 Hz
EUT Highest operating frequency: 108 MHz

4.2 EUT Modification

- N/A

4.3 General Information

- Table-Top
 Floor – Standing
 Table-Top & Floor-Standing (Combination)

4.4 Configuration of the equipment under test

Equipment	Model	Manufacture	Serial No.
NOTE PC	82KD000UKR	LENOVO	-
Adapter	ADLX65CLGR2A	Lite-On Technology Corp.	-

Type	Description	Connection	Spec.	Length(m)
EUT	DC IN	NOTE PC	shield	0.8
	LAN	NOTE PC	Unshield	5.0

Display Observation Distance	1.2 m
The type of cable used to test the networking functionality	Cat.5 (Unshielded Cable)
Data rate when testing networking functionality	100 Mbps
The level selected during the audio output function test	-

4.5 Operating Conditions

The equipment under test was operated during the measurement under following

Test mode	Normal Operating
1	Connect the EUT to the NOTE PC and proceed with the test by checking operation through the 'AX1' program provided by the company.
*	* The electromagnetic wave conduction test (communication port) test was conducted using a program (IBM Exerciser – 100 Mbps).

4.6 The drawing of general test setup

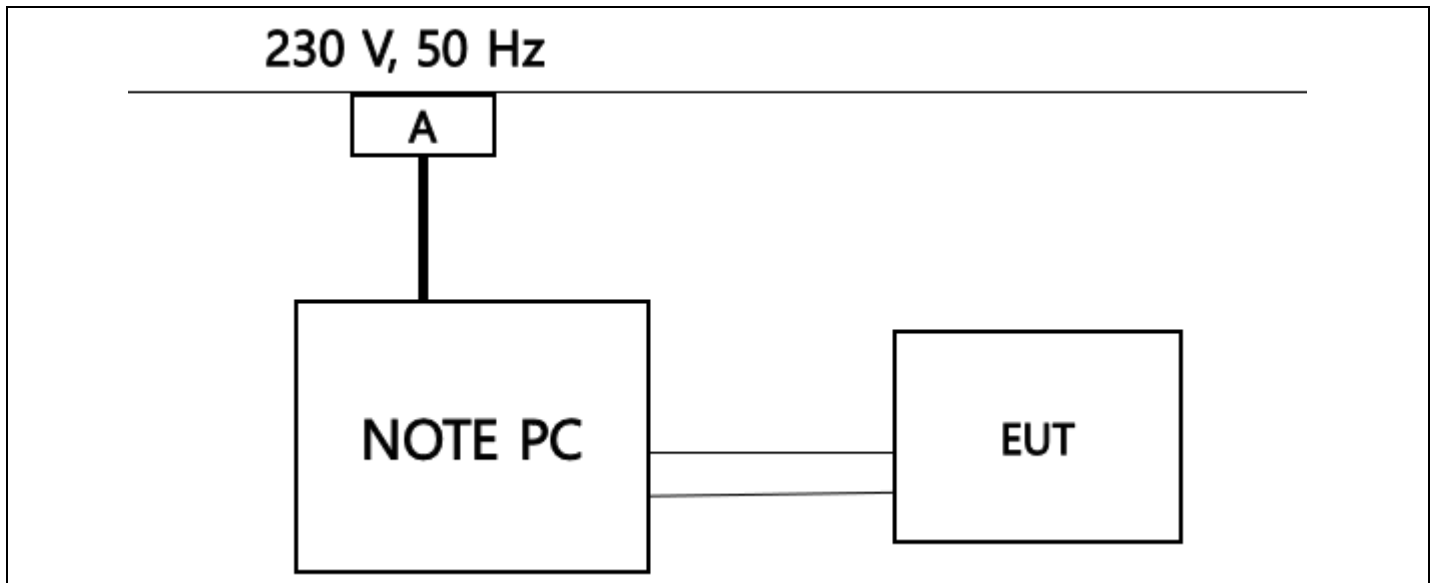

5. Summary of Test Result

5.1 Summary of EMI emission test result

EN 55032 : 2015/A11:2020

Electromagnetic compatibility of multimedia equipment – Emission Requirements.

Test items	Test methods	Result
Conducted Emission (Power Line)	EN55032:2015/A11:2020	Pass
Conducted Emission (Telecommunication Line)	EN55032:2015/A11:2020	Pass
Radiated Emission (Below 1GHz)	EN55032:2015/A11:2020	Pass
Radiated Emission (Above 1GHz)	EN55032:2015/A11:2020	Pass

EN 61000-3-2 : 2019/A1:2021

Limits for harmonic-current emissions (equipment input current up to including 16A per phase)

Test items	Test methods	Result
Harmonics	EN 61000-3-2 : 2019/A1:2021	Pass

EN 61000-3-3 : 2013/A1:2019

Limitation of voltage fluctuations and flicker in public low-voltage supply systems,
for equipment with rated current $\leq 16A$ per phase and not subject to conditional connection

Test items	Test methods	Result
Flicker	EN 61000-3-3: 2013/A1:2019	Pass

5.2 Summary of immunity test result

EN 55035:2017/A11:2020

Electromagnetic compatibility of multimedia equipment – Immunity Requirements.

Test items	Test methods	Result
Electrostatic discharge	EN 61000-4-2:2009	Pass
Electromagnetic field	EN 61000-4-3:2006/A2:2010	Pass
Electric fast transients	EN 61000-4-4:2012	Pass
Surge	EN 61000-4-5:2006	Pass
Conducted Immunity	EN 61000-4-6:2009	Pass
Magnetic field Immunity	EN 61000-4-8:2010	Not application
Voltage dip/interruption	EN 61000-4-11:2004	Pass

5.3 Performance criteria

Performance criterion A

The equipment shall continue to operate as intended without operator intervention. No degradation of performance, loss of function or change of operating state is allowed below a performance level specified by the manufacturer when the equipment is used as intended. The performance level may be replaced by a permissible loss of performance. If the minimum performance level or the permissible performance loss is not specified by the manufacturer, then either of these may be derived from the product description and documentation, and by what the user may reasonably expect from the equipment if used as intended.

Performance criterion B

During the application of the disturbance, degradation of performance is allowed. However, no unintended change of actual operating state or stored data is allowed to persist after the test.

After the test, the equipment shall continue to operate as intended without operator intervention; no degradation of performance or loss of function is allowed, below a performance level specified by the manufacturer, when the equipment is used as intended. The performance level may be replaced by a permissible loss of performance. If the minimum performance level (or the permissible performance loss), or recovery time, is not specified by the manufacturer, then either of these may be derived from the product description and documentation, and by what the user may reasonably expect from the equipment if used as intended.

Performance criterion C

Loss of function is allowed, provided the function is self-recoverable, or can be restored by the operation of the controls by the user in accordance with the manufacturer's instructions. A reboot or re-start operation is allowed. Information stored in non-volatile memory, or protected by a battery backup, shall not be lost.

6. Test Results

6.1 Conducted Emission

Environmental Conditions

Temperature	(22.2 °C)
Humidity	(49 % R.H.)
Test Area	Conducted Room
Test date	2023.09.13

6.1.1 Limits of conducted emission measurement

* Class A equipment

Frequency range (MHz)	Coupling device (EN 55032 see table A.7)	Detector type / bandwidth	Class A limits (dB(μV))
0.15 to 0.50	AMN	Quasi Peak / 9 kHz	79
0.50 to 30			73
0.15 to 0.50	AMN	Average / 9 kHz	66
0.50 to 30			60
* Apply across the entire frequency range.			

* Class B equipment

Frequency range (MHz)	Coupling device (EN 55032 see table A.7)	Detector type / bandwidth	Class B limits (dB(μV))
0.15 to 0.50	AMN	Quasi Peak / 9 kHz	66 – 56
0.50 to 5			56
5 to 30			60
0.15 to 0.50	AMN	Average / 9 kHz	56 – 46
0.50 to 5			46
5 to 30			50
* Apply across the entire frequency range.			

6.1.2 Measurement procedure

Mains

The measurements were performed in a shielded room.

EUT was placed on a non-metallic table height of 0.8 m above the reference ground plane.

The rear of table was located 0.4 m to the vertical conducted plane.

EUT was power through the LISN, which was bonded to the ground plane.

The LISN power was filtered. Each EUT power lead, except ground (safety) lead, was individually connected through a LISN to input power source.

All I.O cables are positioned to simulate typical actual usage according to the test standard.

Both lines of power cord, hot and neutral, were measured.

6.1.3 Used equipments

Equipment	Model	Manufacturer	Serial No.	Next Cal. Date	Used
MEASUREMENT SOFTWARE	EMC32 VER 10.60.15	Rohde&Schwarz	-	-	<input checked="" type="checkbox"/>
Test Receiver	ESR7	Rohde&Schwarz	101616	2024.06.27	<input checked="" type="checkbox"/>
※LISN	ENV216	Rohde&Schwarz	100409	2024.01.09	<input checked="" type="checkbox"/>
LISN	3825-2	EMCO	8901-1458	2024.01.09	<input checked="" type="checkbox"/>
PULSE LIMITER	EPL-30	lignex1	-	2024.01.09	<input checked="" type="checkbox"/>

6.1.4 Test data

- Note. QP = Quasi-Peak, AV= Average
- Loss = LISN Loss + Cable Loss
- Measurement time : 1 s

6.1.5 Test Result

[HOT] - [Multi Tap]

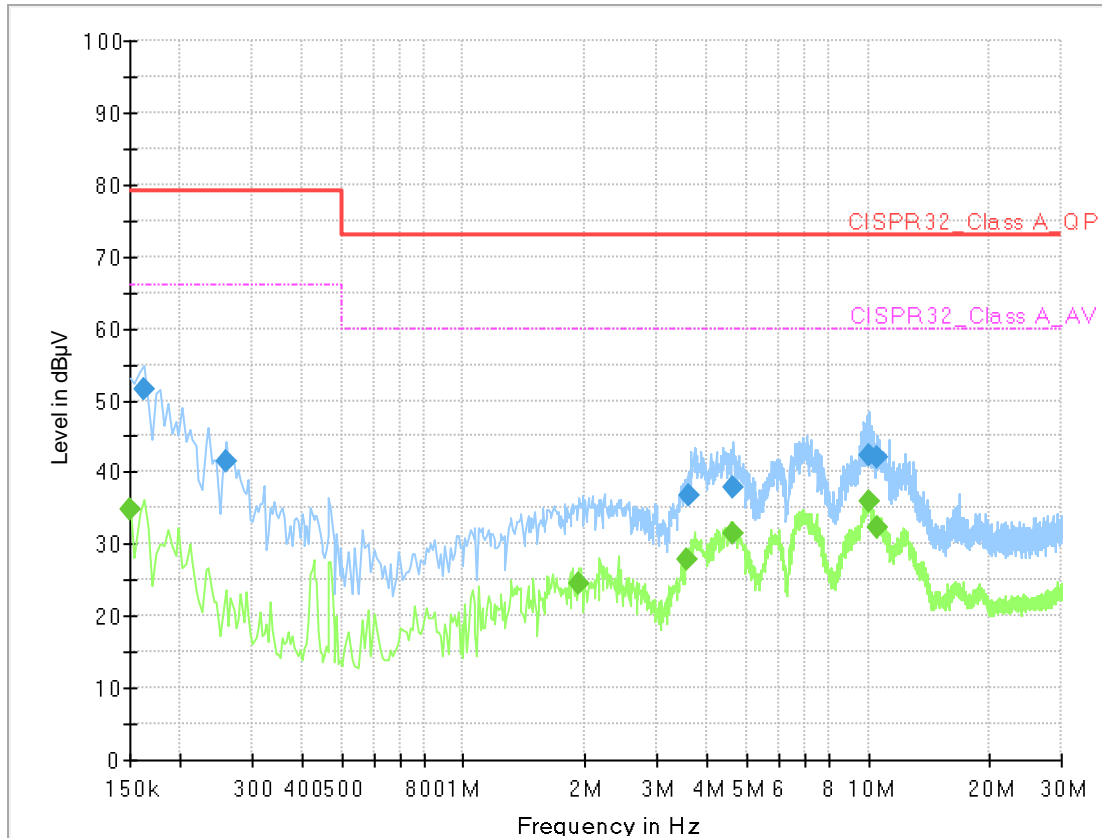

Final Result

Frequency (MHz)	QuasiPeak (dBµV)	CAverage (dBµV)	Limit (dBµV)	Margin (dB)	Bandwidth (kHz)	Line	Corr. (dB)
0.150	---	34.70	66.00	31.30	9	L1	20.0
0.162	51.51	---	79.00	27.49	9	L1	20.1
0.258	41.50	---	79.00	37.50	9	L1	19.8
1.930	---	24.54	60.00	35.46	9	L1	20.5
3.560	---	27.90	60.00	32.10	9	L1	20.9
3.590	36.77	---	73.00	36.23	9	L1	20.9
4.610	---	31.45	60.00	28.55	9	L1	21.3
4.650	37.85	---	73.00	35.15	9	L1	21.3
10.010	---	35.81	60.00	24.19	9	L1	23.2
10.070	42.43	---	73.00	30.57	9	L1	23.3
10.480	42.01	---	73.00	30.99	9	L1	23.4
10.540	---	32.26	60.00	27.74	9	L1	23.4

[NEUTRAL] - [Multi Tap]

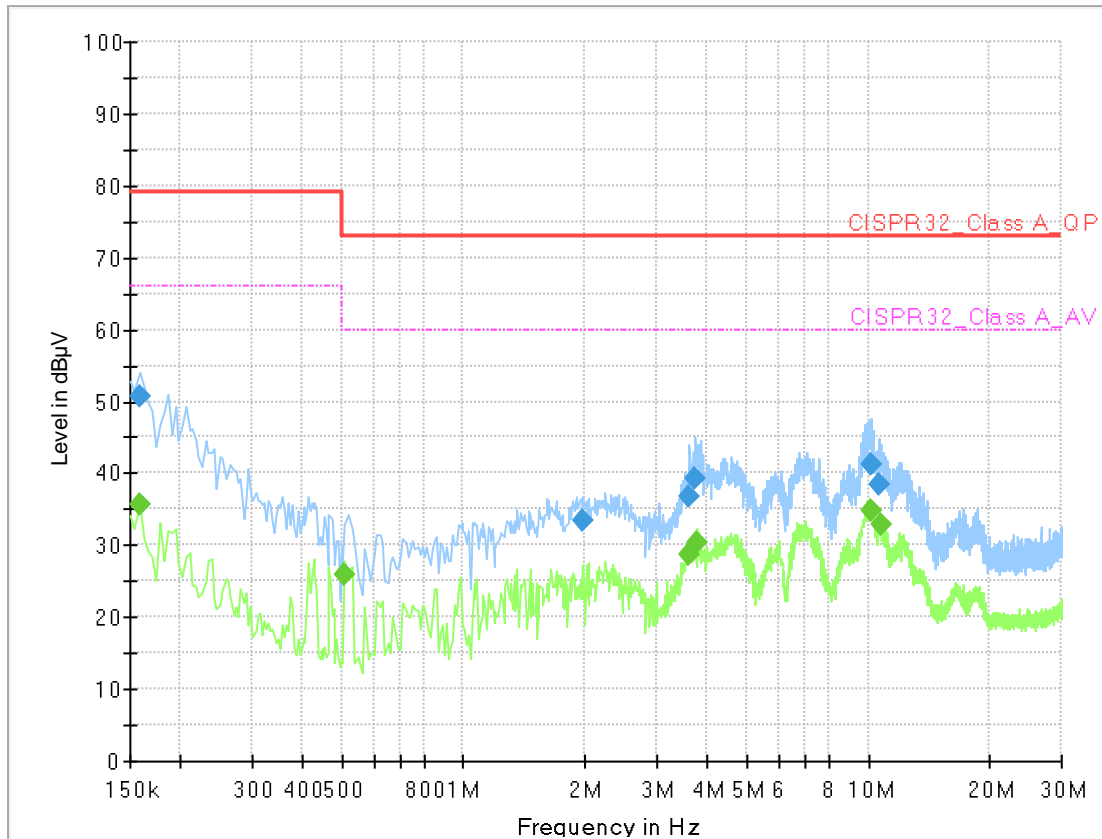

Final Result

Frequency (MHz)	QuasiPeak (dBµV)	CAverage (dBµV)	Limit (dBµV)	Margin (dB)	Bandwidth (kHz)	Line	Corr. (dB)
0.158	---	35.53	66.00	30.47	9	N	19.9
0.158	50.61	---	79.00	28.39	9	N	19.9
0.510	---	26.01	60.00	33.99	9	N	19.9
1.980	33.31	---	73.00	39.69	9	N	20.0
3.590	36.69	---	73.00	36.31	9	N	20.1
3.600	---	28.65	60.00	31.35	9	N	20.1
3.740	39.29	---	73.00	33.71	9	N	20.2
3.760	---	30.24	60.00	29.76	9	N	20.2
10.110	41.09	---	73.00	31.91	9	N	21.6
10.130	---	34.86	60.00	25.14	9	N	21.6
10.680	38.56	---	73.00	34.44	9	N	21.8
10.720	---	32.73	60.00	27.27	9	N	21.8

6.2 Conducted Emission(Telecommunications/network)

Environmental Conditions

Temperature	(22.2 °C)
Humidity	(49 % R.H.)
Test Area	Conducted Room
Test date	2023.09.13

6.2.1 Measurement procedure

Telecommunications/network

All power was connected to the system through Artificial Mains Network (AMN). All tested telecommunications lines were connected to an Asymmetric Artificial Network (AAN) and conducted voltage measurements on telecommunications lines were made at the output of the AAN. Where an AAN was not appropriate or available measurements were made using a Capacitive Voltage Probe and Current probe.

* For Ethernet interfaces, measurements are required at the highest data rate supported by the interface.

6.2.2 Used equipments

Equipment	Model	Manufacturer	Serial No.	Next Cal. Date	Used
MEASUREMENT SOFTWARE	EMC32 VER 10.60.15	Rohde&Schwarz	-	-	<input checked="" type="checkbox"/>
Test Receiver	ESR7	Rohde&Schwarz	101616	2024.06.27	<input checked="" type="checkbox"/>
※LISN	ENV216	Rohde&Schwarz	100409	2024.01.09	<input checked="" type="checkbox"/>
LISN	3825-2	EMCO	8901-1458	2024.01.09	<input checked="" type="checkbox"/>
ISN	CAT3 8158	SCHWARZBECK	CAT3-8158-0018	2024.03.14	<input type="checkbox"/>
ISN	CAT5 8158	SCHWARZBECK	CAT5-8158-0033	2024.03.14	<input checked="" type="checkbox"/>
ISN	CAT6 8158	SCHWARZBECK	8158-0033	2024.03.14	<input type="checkbox"/>
ISN	ST08	TESEQ	41234	2024.06.27	<input type="checkbox"/>
CDN	S1-75 BNC	EM TEST	P1408132027	2024.06.27	<input type="checkbox"/>
RF Current Probe	F-65	FCC	292	2024.09.12	<input type="checkbox"/>
PULSE LIMITER	EPL-30	lignex l	-	2024.01.09	<input checked="" type="checkbox"/>

6.2.3 Test Result

[100 Mbps]

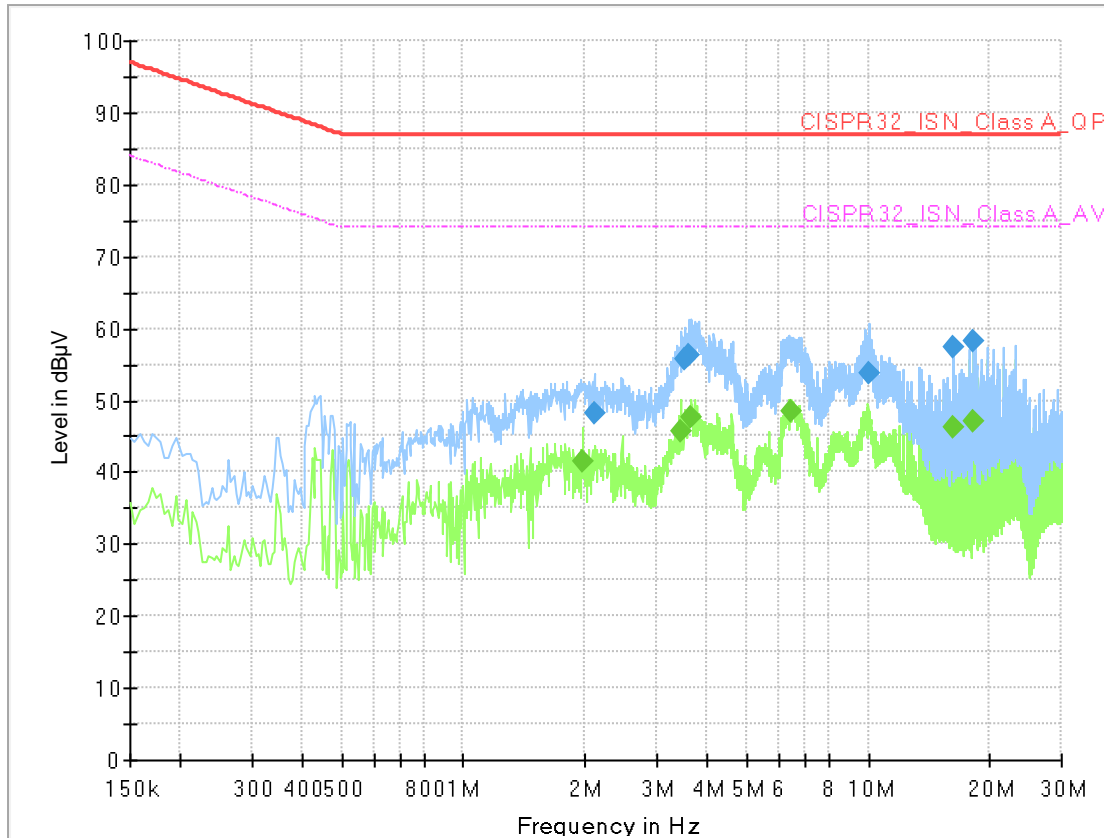

Final Result

Frequency (MHz)	QuasiPeak (dBµV)	CAverage (dBµV)	Limit (dBµV)	Margin (dB)	Bandwidth (kHz)	Corr. (dB)
1.964	---	41.41	74.00	32.59	9	19.4
2.100	48.19	---	87.00	38.81	9	19.4
3.444	---	45.74	74.00	28.26	9	19.4
3.524	55.62	---	87.00	31.38	9	19.4
3.620	56.25	---	87.00	30.75	9	19.4
3.648	---	47.67	74.00	26.33	9	19.4
6.424	---	48.45	74.00	25.55	9	19.4
10.000	53.78	---	87.00	33.22	9	19.4
16.228	57.31	---	87.00	29.69	9	19.6
16.228	---	46.18	74.00	27.82	9	19.6
18.244	---	47.20	74.00	26.80	9	19.6
18.244	58.27	---	87.00	28.73	9	19.6

6.3 Radiated emission

Environmental Conditions

Temperature	(22.1 °C) - Semi anechoic chamber (10m) (22.3 °C) - Fully anechoic chamber(3m)
Humidity	(48 % R.H.) - Semi anechoic chamber (10m) (49 % R.H.) - Fully anechoic chamber(3m)
Test Area	Semi anechoic chamber (10m) – Below 1GHz Fully anechoic chamber(3m) – Above 1GHz
Test date	2023.09.12 - Semi anechoic chamber (10m) 2023.09.13 - Fully anechoic chamber(3m)

6.3.1 Limits of radiated emission measurement

*Limits below 1GHz

* Class A equipment

Frequency range (MHz)	Measurement		Class A limits (dB(μV/m))
	Distance (m)	Detector type/ bandwidth	OATS/SAC
30 to 230	10	Quasi Peak / 120 kHz	40
230 to 1 000			47
30 to 230	3		50
230 to 1 000			57

* Class B equipment

Frequency range (MHz)	Measurement		Class B limits (dB(μV/m))
	Distance (m)	Detector type/ bandwidth	OATS/SAC
30 to 230	10	Quasi Peak / 120 kHz	30
230 to 1 000			37
30 to 230	3		40
230 to 1 000			47

*Limits above 1GHz

* Class A equipment

Frequency range (MHz)	Measurement		Class A limits (dB(μV/m))
	Distance (m)	Detector type/ bandwidth	FSOATS
1 to 3	3	Average / 1 MHz	56
3 to 6			60
1 to 3		Peak / 1 MHz	76
3 to 6			80

* Class B equipment

Frequency range (MHz)	Measurement		Class B limits (dB(μV/m))
	Distance (m)	Detector type/ bandwidth	FSOATS
1 to 3	3	Average / 1 MHz	50
3 to 6			54
1 to 3		Peak / 1 MHz	70
3 to 6			74

6.3.2 Measurement procedure

Mains

A test was performed at 3m & 10m distance in a semi-anechoic chamber for searching correct frequency. The final test was done at a 10m/3m semi-anechoic chamber with a quasi-peak detector peak detector & average detector.

EUT was placed on a non-metallic table height of 0.8m above the reference ground plane.

Cables were folded back and forth forming a bundle 0.3m to 0.4m long and were hanged at a 0.4m height to the ground plane.

Cables connected to EUT were fixed to cause maximum emission.

Test was made with the antenna positioned in both the horizontal and vertical planes of polarization.

The measurement antenna was varied in height above the conducting ground plane to obtain the maximum signal strength.

6.3.3 Used equipments

* Below 1GHz

Equipment	Model no	Manufacturer	Serial no.	Next cal. date	Used
MEASUREMENT SOFTWARE	EMC32 VER 10.60.15	Rohde&Schwarz	-	-	<input type="checkbox"/>
Spectrum Analyzer	E4401B	HP.Agilent	US39440387	2024.06.27	<input checked="" type="checkbox"/>
EMI TEST RECEIVER	ESVS10	ROHDE&SCHWARZ	846285/004	2024.06.27	<input checked="" type="checkbox"/>
Controllers	CO3000-4port	Innco Systems GmbHRE	CO3000/ 1060/ 42111117/P	-	<input checked="" type="checkbox"/>
Antenna Masts	MA4640/800-XP- ET	Innco Systems GmbHRE	-	-	<input checked="" type="checkbox"/>
Turn tables	DS3000-S-1t	Innco Systems GmbHRE	-	-	<input checked="" type="checkbox"/>
AMPLIFIER	PO-LS960	PANOPTICS	PL181004	2024.06.27	<input checked="" type="checkbox"/>
Bi-Log Ant	VULB9168	Schwarzbeck	902	2023.11.30	<input checked="" type="checkbox"/>

* Above 1GHz

Equipment	Model no	Manufacturer	Serial no.	Next cal. date	Used
MEASUREMENT SOFTWARE	EMC32 VER 10.60.15	Rohde&Schwarz	-	-	<input checked="" type="checkbox"/>
EMI TEST RECEIVER	ESW44	Rohde&Schwarz	101952	2024.03.14	<input checked="" type="checkbox"/>
Controllers	CO3000-4port	Innco Systems GmbHRE	CO3000/ 1061/ 42111117/P	-	<input checked="" type="checkbox"/>
Antenna Masts	MA4640/800-XP- ET	Innco Systems GmbHRE	-	-	<input checked="" type="checkbox"/>
Turn tables	DS2000-S-1t	Innco Systems GmbHRE	-	-	<input checked="" type="checkbox"/>
Horn ANT	BBHA9120D	Schwarzbeck	974	2023.11.29	<input checked="" type="checkbox"/>
AMPLIFIER	TK-PA18H	TESTEK	220104-L	2024.03.14	<input checked="" type="checkbox"/>

6.3.4 Test data

* Receiving Antenna Mode : Horizontal, Vertical

* Note : Total Reading = Test Receiver meter,

Reading = Correction(Antenna factor + Cable factor - Amp Gain)

Pol.= Polarization → H = Horizontal, V = Vertical

Result [dB(μV/m)] = Total reading [dB(μV)] + AF [dB/m] + CL [dB] - AG [dB]

6.3.5 Test Result

[Below 1GHz]

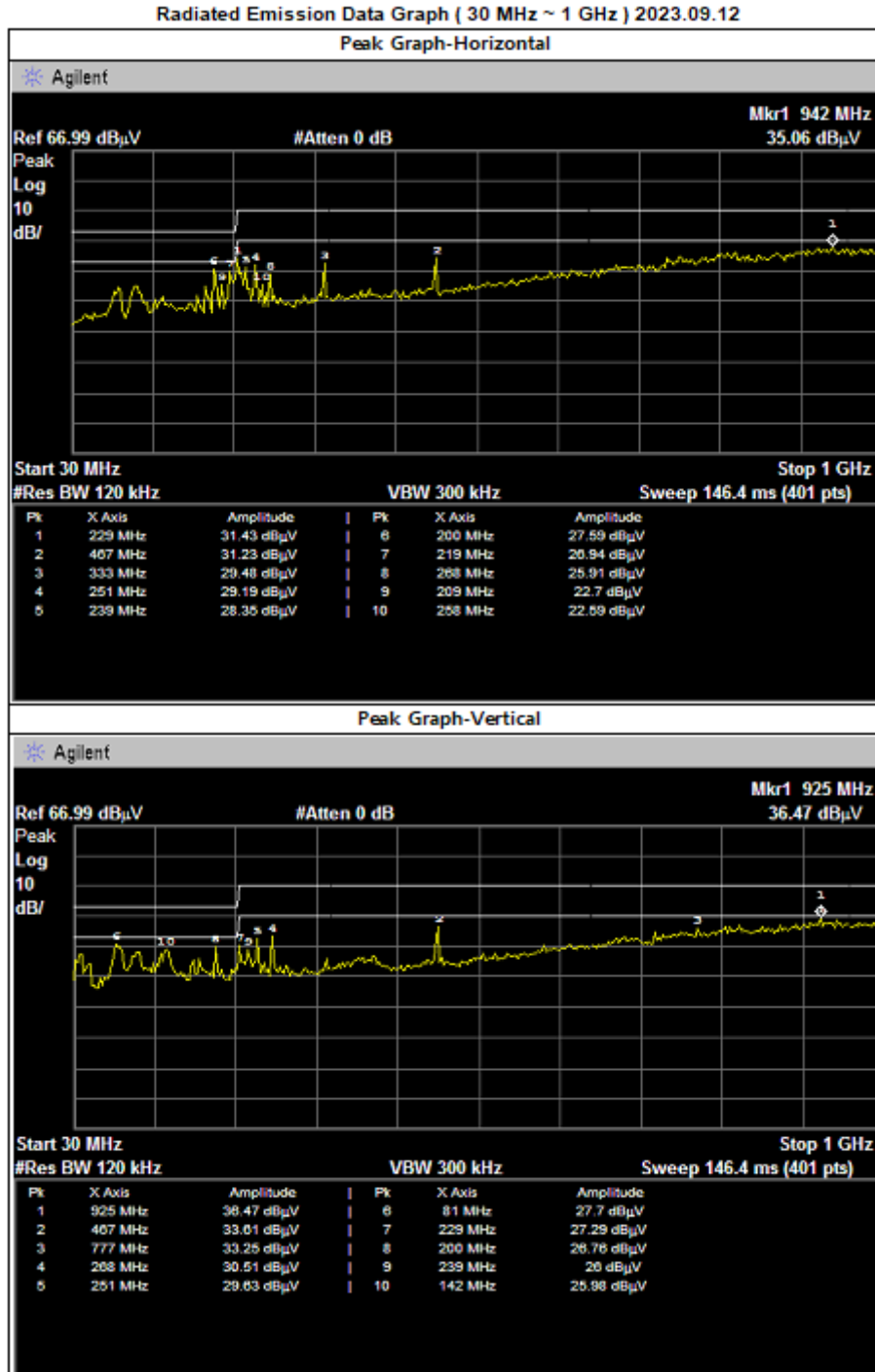

***10m Chamber Scan Data**

제품명 : iEthernet Module
 모델명 : W5100S-EVB-Pico
 제조사 : WIZNET Co., Ltd

측정일 : 2023.09.12
 모 드 : Operation

A

Frequency [MHz]	Total Reading [dB μ V/m]	Pol.	Height [m]	angle [°]	Quasi-Peak [dB μ V/m]	Correction			Limits [dB μ V/m]	Result [dB μ V/m]	Margin [dB]
						Antenna [dB/m]	Cable [dB]	Amp Gain [dB]			
80.27	55.20	V	1.1	45	(27.30)	8.70	4.40	40.40	40	27.90	12.10
218.66	50.90	H	4.0	90	(23.96)	9.78	7.12	40.86	40	26.94	13.06
229.15	54.60	H	4.0	200	(23.21)	10.36	7.31	40.88	40	31.39	8.61
467.92	47.80	V	1.0	270	(14.18)	17.16	11.04	42.37	47	33.62	13.38
777.57	37.90	V	1.1	160	(4.75)	22.24	14.82	41.80	47	33.15	13.85
925.48	38.90	V	1.1	30	(2.54)	23.70	16.20	42.44	47	36.36	10.64

[Above 1GHz]

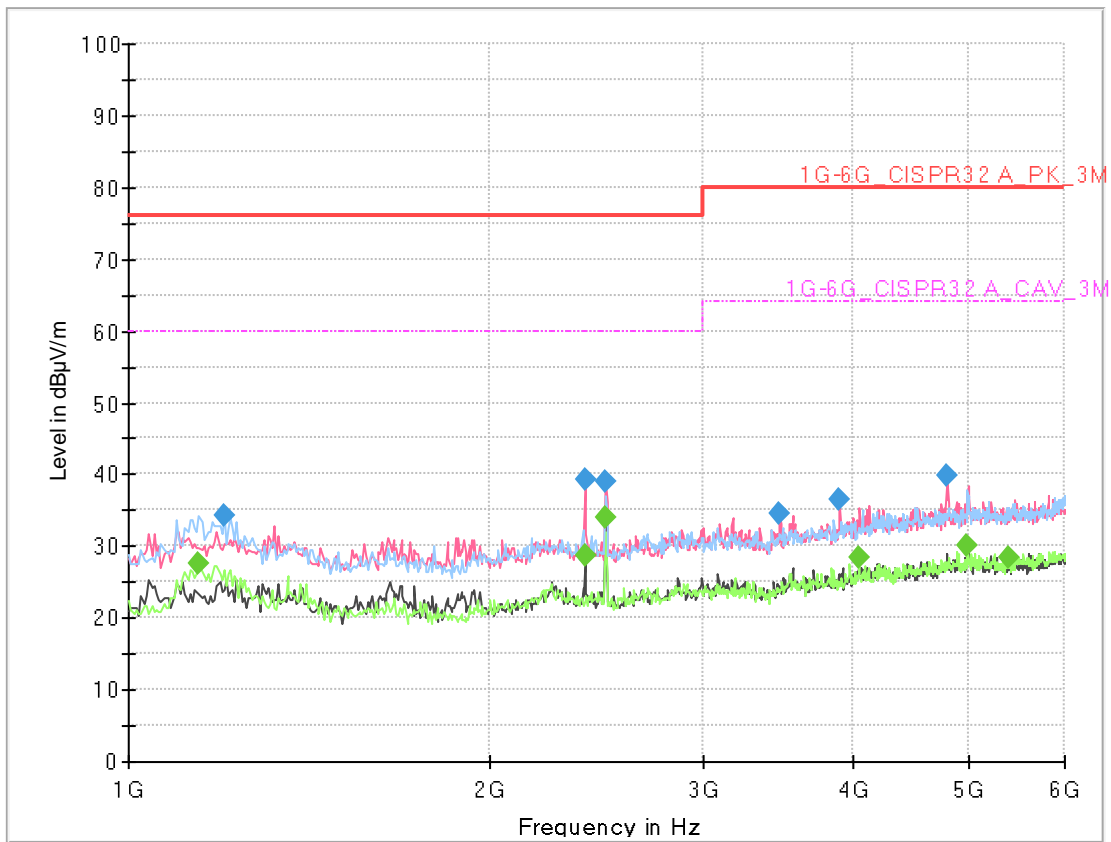

Final Result

Frequency (MHz)	MaxPeak (dBµV/m)	CAverage (dBµV/m)	Limit (dBµV/m)	Margin (dB)	Bandwidth (kHz)	Height (cm)	Pol	Azimuth (deg)	Corr. (dB/m)
1145.00	---	27.61	60	32.39	1000	100	H	150	-16.6
1200.00	34.31	---	76	41.69	1000	100	H	183	-16.1
2395.00	---	28.56	60	31.44	1000	100	V	120	-12.1
2395.00	39.29	---	76	36.71	1000	100	V	120	-12.1
2490.00	---	34.06	60	25.94	1000	100	V	0	-12.0
2495.00	38.95	---	76	37.05	1000	100	V	0	-12.0
3480.00	34.52	---	80	45.48	1000	100	V	84	-9.0
3900.00	36.39	---	80	43.61	1000	100	V	0	-6.9
4050.00	---	28.43	64	35.57	1000	100	H	219	-6.4
4795.00	39.90	---	80	40.10	1000	100	V	119	-2.3
4985.00	---	30.01	64	33.99	1000	100	H	260	-1.4
5395.00	---	28.36	64	35.64	1000	100	H	3	-0.2

6.4 Electrostatic Discharge

Environmental Conditions

Temperature	(22.3 °C)
Humidity	(48 % R.H.)
Atmosphere pressure	(100.1 kPa)
Test Area	EMC Test Room
Test date	2023.09.16

6.4.1 Measurement procedure

A ground reference plane was located on the floor, and connected to earth via a low impedance connection. The return cable of the ESD generator was connected to the reference plane. In case of floor standing equipment, EUT was placed on the reference plane on 0.1 m of insulating Support.

In case of table top equipment, EUT was placed on a wooden table 0.8m above the reference grounded floor.

A horizontal coupling plane(HCP) was placed on the table, and Connected to the reference plane via a 470 resistor located in each end (0.5mm insulating support between EUT and HCP).

In both cases a vertical coupling plane(VCP) OF 0.5 X 0.5m was located 10cm from the EUT's sides.

The VCP was connected to the reference plane in the same matter as the HCP.

6.4.2 Used equipments

Equipment	Model No.	Manufacturer	Serial No.	Next Cal. Date	Used
ESD SIMULATOR	PESD1610	HAEFELY	H810682	2024.07.11	<input type="checkbox"/>
ESD SIMULATOR	ESS-B3011	NOISEKEN	ESS1796831	2024.07.18	<input checked="" type="checkbox"/>

6.4.3 Test Data

Test Specification : EN 61000-4-2:2009

Kind of Discharges

- Contact Discharge
- Air Discharge
- HCP / VCP (Indirect Discharge)

Discharge Voltages

- Contact Discharge : ± 4 kV
- Air Discharge : $\pm 2 / 4 / 8$ kV
- HCP / VCP : ± 4 kV

Discharge Impedance

- 330 Ω /150pF 2K Ω /330pF

Number Of Discharge

- Number of discharges per point, for each voltage and polarity
: 20 (Interval between discharges : ≥ 1 s)

Test point (Please refer to attached photograph.)

Test Results

- Complied Not complied

Comment :

- There was no change of operation status during above testing.

Electrostatic Discharge (Test Point)

Air discharge →
Contact discharge →

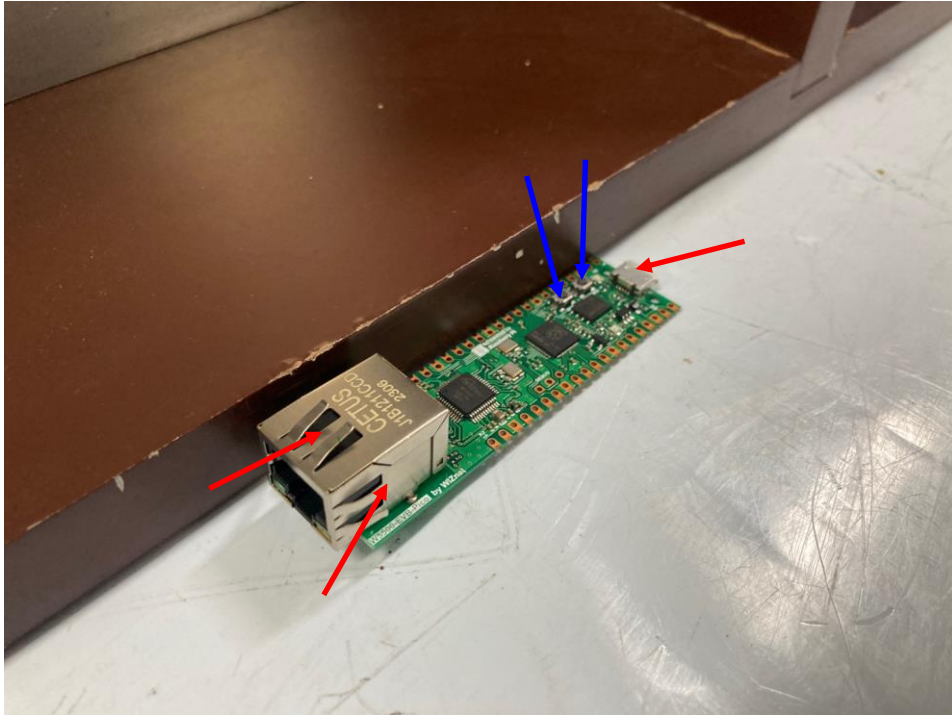

[front]

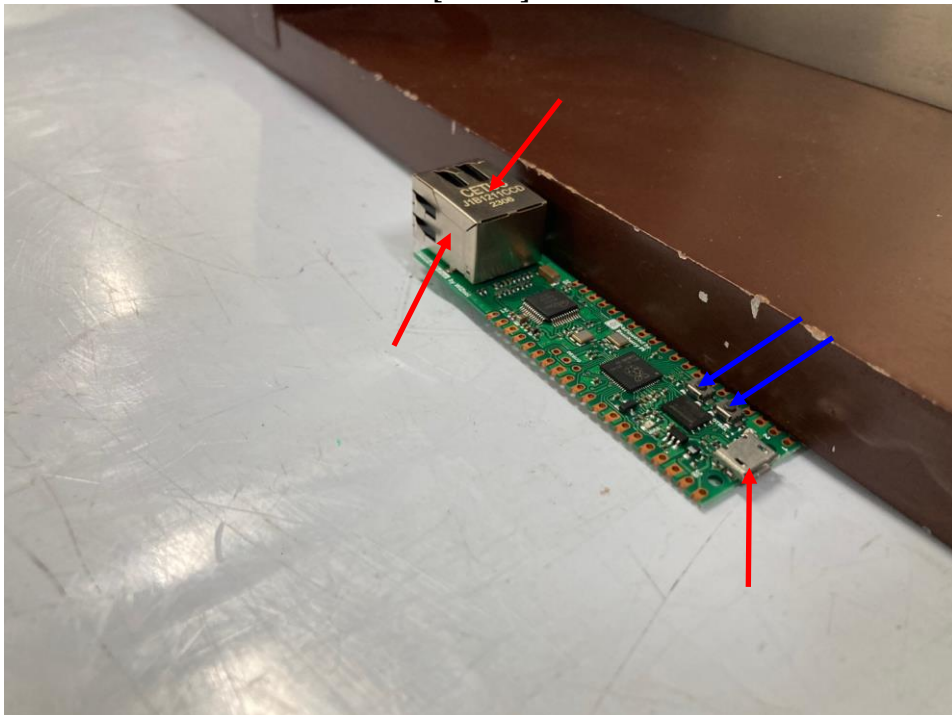

[rear]

Indirect Discharge

	Test Point	Kind of Discharge	Performance Criteria	Result	Remark
Indirect	HCP	Contact	B	A	
	VCP			A	

Direct Discharge

Direct	Lan, Dc In Port	Contact	B	A	
	-	Air		-	
	Button	Air (non discharge)		A	

6.5 Radio Frequency Electromagnetic Fields

Environmental Conditions

Temperature	(22.2 °C)
Humidity	(48 % R.H.)
Test Area	RS Chamber
Test date	2023.09.15

6.5.1 Measurement procedure

The test was performed at 3m full anechoic chamber.

For floor standing equipment, the EUT was standing on the floor.

For tabletop equipment, the EUT was located on a wooden table 0.8m above the floor.

The EUT was tested all sides, horizontal and vertical polarization.

The field uniformity was calibrated for 3V/m.

6.5.2 Used equipments

Equipment	Model no.	Manufacturer	Serial no.	Next Cal. date	Used
RADIATED SUSCEPTIBILITY SOFTWARE	I2 20180112 (v5)	Audix	-	-	<input checked="" type="checkbox"/>
Signal Generator	8665B	HP	3315A00341	2023.12.14	<input checked="" type="checkbox"/>
Amplifier	150W1000M2	AR	0331745	-	<input checked="" type="checkbox"/>
Amplifier	ITRS-1030A50	Infitech	20121000001	-	<input checked="" type="checkbox"/>
Amplifier	ES3060BP60	SUNGSAN	SA1031-OPT1-0002	-	<input checked="" type="checkbox"/>
Power Meter	E4419B	AGILENT	MY41291980	2024.05.10	<input checked="" type="checkbox"/>
Power Head Sensor	E9301A	AGILENT	US39212396	2024.05.10	<input checked="" type="checkbox"/>
Power Head Sensor	E9301A	AGILENT	US39210340	2024.05.10	<input checked="" type="checkbox"/>
Directional Coupler	DC6180A	AR	0331175	2024.05.10	<input checked="" type="checkbox"/>
Coaxial Directional Coupler	M2001-2801	-	M2001-0001	2024.09.12	<input checked="" type="checkbox"/>
Antenna	3142D	ETS LINDGREN	00102179	-	<input checked="" type="checkbox"/>
RADIATED SUSCEPTIBILITY SOFTWARE	I2 190813a (v5)	Audix	-	-	<input type="checkbox"/>
Amplifier	ESU210BP300	Sungsan	SA8015-0001	-	<input type="checkbox"/>
Amplifier	ES1060BP100	Sungsan	SA8016-0001	-	<input type="checkbox"/>
Directional Coupler	DCU210P300-40	Sungsan	DC1001-0003	2024.09.12	<input type="checkbox"/>
Directional Coupler	DCU1060P100-40	Sungsan	DC0034-0002	2024.09.12	<input type="checkbox"/>
Rack & Switch Control Box	-	Sungsan	-	-	<input type="checkbox"/>
Log Periodic Antenna	VULP9118E	Schwarzbeck	1015	-	<input type="checkbox"/>
Log Periodic Antenna	STLP9149	Schwarzbeck	677	-	<input type="checkbox"/>
Power meter	E4419B	Agilent	GB43312904	2024.05.10	<input type="checkbox"/>
Power sensor	8481A	Agilent	2702A58374	2024.09.12	<input type="checkbox"/>
Power sensor	8481A	Agilent	1926A28196	2024.09.12	<input type="checkbox"/>
Signal Generator	APSIN6010HC	Anapico	111-433600410-1298	2024.09.12	<input type="checkbox"/>
Audio Acoustic Tester	TST-1000	TESTEK	230104-A	2024.02.16	<input type="checkbox"/>
Impedance Box	TIB-R1	TESTEK	230106-R	-	<input type="checkbox"/>
Field Probe	FL7006	AR	0344233	2024.01.16	<input type="checkbox"/>
Field Monitor	FM7004	AR	0330923	-	<input type="checkbox"/>
Laser Probe Interface	FI7000	AR	0344349	-	<input type="checkbox"/>

6.5.3 Test Data

Test Specification : EN 61000-4-3:2006/A2:2010

Frequency Range

80MHz – 1000MHz 1400 MHz – 2000MHz 2000 MHz – 2700 MHz 80MHz – 2500MHz

1.8 GHz, 2.6GHz, 3.5GHz, 5GHz (Spot Frequency)

Test level

1V/m 3V/m 10V/m

Modulation

AM : 1kHz, 80%

PM :

Frequency step

log 1% step log 3% step log 5% step

Dwell Time

3 s 2 s 1 s

Test point

Front (Horizontal / Vertical)

Rear (Horizontal / Vertical)

Left (Horizontal / Vertical)

Right (Horizontal / Vertical)

Audio output function

Possible Impossible

Test Results

Complied Not complied

Comment :

- There was no change of operation status during above testing. .

6.6 Electric Fast Transient/BURST

Environmental Conditions

Temperature	(22.1 °C)
Humidity	(49 % R.H.)
Test Area	EMC Test Room
Test date	2023.09.15

6.6.1 Measurement procedure

A ground reference plane was located on the floor.

EFT generator was connected to reference ground plane via low impedance connection.

For floor standing equipment, EUT was placed on a 0.1 m wooden table.

For tabletop equipment, EUT was placed on a wooden table(0.1m) above the reference plane.

Test generator and coupling/decoupling network was placed on, and bounded to, the ground reference plane.

When using the coupling clamp, the minimum distance between the coupling plates and all other conductive surfaces, except the ground reference plane beneath the coupling clamp, Shall be 0.5 m.

6.6.2 Used equipments

Equipment	Model No.	Manufacturer	Serial No.	Next Cal. date	Used
IMMUNITY TEST SOFTWARE	IEC.CONTROL VER 9.2.2	AMETEK CTS GmbH	-	-	<input checked="" type="checkbox"/>
MULTIFUNCTIONAL TEST GENERATOR	compact NX5	EM Test	P1725200197	2024.05.10	<input checked="" type="checkbox"/>
Motorized Variac	variac NX1-260-16	EM Test	P1745207277	-	<input checked="" type="checkbox"/>
CAPACITIVE COUPLING CLAMP	CCL	EM Test	P1745207364	2024.05.10	<input checked="" type="checkbox"/>

6.6.3 Used equipments

Test Specification : EN 61000-4-4:2012

Location of Coupling (AC cable Length : 0.5m)

Power Signal Lines Telecommunication line

Test level

Power : 1 kV
 Signal Line : 0.5 kV
 Tel. line :

Burst frequency : 5 kHz, 5/50 ns

Coupling Time : > 60 s

Test Results

Complied Not complied

Coupling Point (AC main)	Polarity	Levels (kV)	Results (criterion)
L-N	±	1 (kV)	A

Coupling Point (Clamp)	Polarity	Levels (kV)	Results (criterion)
LAN Cable	±	0.5 (kV)	A

Comment :

- There was no change of operation status during above testing.

6.7 Surge

Environmental Conditions

Temperature	(22.1 °C)
Humidity	(49 % R.H.)
Test Area	EMC Test Room
Test date	2023.09.15

6.7.1 Measurement procedure

A ground reference plane was located on the floor.

SURGE generator was connected to reference ground plane via low impedance connection.

For floor standing equipment, EUT was placed on a 0.8 m wooden table.

For tabletop equipment, EUT was placed on a wooden table(0.8m) above the reference plane.

The following additional pulses are required only if the EUT has an earth connection or if the EUT is earthed via any AE.

6.7.2 Used equipments

Equipment	Model No.	Manufacturer	Serial No.	Next Cal. date	Used
IMMUNITY TEST SOFTWARE	IEC.CONTROL VER 9.2.2	AMETEK CTS GmbH	-	-	<input checked="" type="checkbox"/>
MULTIFUNCTIONAL TEST GENERATOR	compact NX5	EM Test	P1725200197	2024.05.10	<input checked="" type="checkbox"/>
Motorized Variac	variac NX1-260-16	EM Test	P1745207277	-	<input checked="" type="checkbox"/>
CDN	CNV 508N1	EM Test	P1742204935	2024.06.27	<input type="checkbox"/>
CDN	CNV 508T5	EM Test	P1742204981	2024.06.27	<input type="checkbox"/>

6.7.3 Test data

Test Specification : EN 61000-4-5:2006

Location of Coupling (AC cable Length : 1.2 m)

AC Power Signal Lines Telecommunication line

Test level

Power Line to Line : $\pm 0.5/1$ kV Line to Ground : $\pm 0.5/1/2$ kV

Signal Line :

Tel. line :

Surge Pulse Shape : Tr / Th = 1.2 / 50

Test mode

- AC Power : L-N-PE

-Signal Line :

Coupling Impedance

18uF : Line to Line 10 Ω +9uF : Line to Ground 40 Ω +0.1uF 18uF : Tel line

40 Ω +0.5uF

Coupling Time : > 1 min

Number of Surge : 5

Angle : 0 90 180 270

Test Results

Complied Not complied

Coupling Point (AC)	Polarity	Levels (kV)	Results (criterion)
L-N	\pm	0.5/1 (kV)	A

Comment :

- There was no change of operation status during above testing.

6.8 Conducted Immunity

Environmental Conditions

Temperature	(22.1 °C)
Humidity	(49 % R.H.)
Test Area	EMC Test Room
Test date	2023.09.17

6.8.1 Measurement procedure

A ground reference plane was located on the floor.

The EUT was isolated 0.1 m isolating support.

The ground plane was connected to floor reference ground plane via low impedance connection.

This test were Performed using CDN for mains, clamp for signal and injection probe.

6.8.2 Used equipments

Equipment	Model no.	Manufacturer	Serial no.	Next Cal. date	Used
Conducted Susceptibility software	ICD.CONTROL VER 6.1.3	AMETEK CTS GmbH	-	-	<input checked="" type="checkbox"/>
CS GENERATOR	NSG 4070	TESEQ	48185	2024.01.09	<input checked="" type="checkbox"/>
Attenuator (6dB)	ATN 6150	TESEQ	17091901	2024.06.27	<input checked="" type="checkbox"/>
CDN	M016	TESEQ	49312	2024.06.27	<input checked="" type="checkbox"/>
EM Injection Clamp	F-2031-23MM	FCC	091219	2024.05.10	<input checked="" type="checkbox"/>
CDN	F-801-M3-16A	FCC	091282	2024.05.10	<input checked="" type="checkbox"/>
CDN	ISN ST08	TESEQ	41234	2024.06.27	<input type="checkbox"/>
CDN	CDN S1-75 BNC	TESEQ	P1408132027	2024.06.27	<input type="checkbox"/>
Decoupling Network	F-2031-DCN-23MM	FCC	091221	-	<input type="checkbox"/>
Audio Acoustic Tester	TST-1000	TESTEK	150068-A	2023.11.07	<input type="checkbox"/>
Impedance Box	TIB-R1	TESTEK	150059-R	-	<input type="checkbox"/>

6.8.3 Test Data

Test Specification : EN 61000-4-6:2009

Frequency Range

Frequency (MHz)	Voltage Level (r.m.s.) (V)
0.15 to 10	3
10 to 30	3 to 1
30 to 80	1

Location of Coupling (AC cable Length : 0.3 m)

Power Signal Lines Telecommunication line

Modulation

AM : 1kHz, 80%
 PM : 1Hz (0.5 s ON : 0.5 s OFF)

Frequency step

log 1% step log 3% step log 5% step

Dwell Time

3 s 2 s 1 s

Audio output function

Possible Impossible

Test Results

Complied Not complied

Coupling Point (AC)	Coupling Method	Results (criterion)
POWER	CDN (M2)	A

Coupling Point (Signal)	Coupling Method	Results (criterion)
LAN Cable #1~#6	EM Injection Clamp	A

Comment :

- There was no change of operation status during above testing.

6.9 Magnetic field Immunity

Environmental Conditions

Temperature	(°C)
Humidity	(% R.H.)
Test Area	EMC Test Room
Test date	

6.9.1 Measurement procedure

The test was performed on a ground reference plane (GRP) on a 0.1m wooden table.

The EUT was isolated 10 cm isolating support.

The ground plane was connected to floor reference ground plane via low impedance connection.

The test generator was placed 3m distance from the induction coil. The generator was connected reference ground plane.

Preliminary verification of equipment performances was carried out prior to applying the test magnetic field. The field was applied to the EUT horizontal, vertical polarization.

6.9.2 Used equipments

Equipment	Model No.	Manufacturer	Serial No.	Next Cal. date	Used
IMMUNITY TEST SOFTWARE	IEC.CONTROL VER 9.2.2	AMETEK CTS GmbH	-	-	<input type="checkbox"/>
MULTIFUNCTIONAL TEST GENERATOR	compact NX5	EM Test	P1725200197	2024.05.10	<input type="checkbox"/>
Motorized Variac	variac NX1-260-16	EM Test	P1745207277	-	<input type="checkbox"/>
Current transformer	MC 2630	EM Test	P1730202035	2024.06.27	<input type="checkbox"/>
Magnetic field coil	MS 100N	EM Test	P1738203462	2024.06.27	<input type="checkbox"/>

6.9.3 Test data

Test specification : EN 61000-4-8:2010

Magnetic field strength : 1A/m 3A/m 30A/m

Frequency : 50Hz 60Hz

Polarization : Horizontal Vertical

Coupling time : 60s \geq

Positions	Test level	Results (criterion)
X	A/m	-
Y	A/m	-
Z	A/m	-

Comment :

- Not Applicable.

6.10 Dips and Interruptions

Environmental Conditions

Temperature	(22.1 °C)
Humidity	(48 % R.H.)
Test Area	EMC Test Room
Test date	2023.09.15

6.10.1 Measurement procedure

The dips/interruption test is only applicable to AC mains.
The dips/interruptions were applied at zero crossing.

6.10.2 Used equipments

Equipment	Model no.	Manufacturer	Serial no.	Next Cal. date	Used
IMMUNITY TEST SOFTWARE	IEC.CONTROL VER 9.2.2	AMETEK CTS GmbH	-	-	<input checked="" type="checkbox"/>
MULTIFUNCTIONAL TEST GENERATOR	compact NX5	EM Test	P1725200197	2024.05.10	<input checked="" type="checkbox"/>
Motorized Variac	variac NX1-260-16	EM Test	P1745207277	-	<input checked="" type="checkbox"/>

6.10.3 Test data

Test specification : EN 61000-4-11:2004

- Normal Voltage / Frequency :
- | | |
|--|---|
| <input type="checkbox"/> 115Vac / 50Hz | <input checked="" type="checkbox"/> 230Vac / 50Hz |
| <input type="checkbox"/> 100Vac / 50Hz | <input type="checkbox"/> 240Vac / 60Hz |
| <input type="checkbox"/> 100Vac / 60Hz | <input type="checkbox"/> 240Vac / 50Hz |
| <input type="checkbox"/> Dips (40%) | |
| <input checked="" type="checkbox"/> Dips (70%) | |
| <input checked="" type="checkbox"/> Dips (> 95%) | |
| <input checked="" type="checkbox"/> Interruption (> 95%) | |
- Event time :
- | | | |
|---|--|--|
| <input checked="" type="checkbox"/> 25P | <input checked="" type="checkbox"/> 0.5P | <input checked="" type="checkbox"/> 250P |
| <input type="checkbox"/> 1P | <input type="checkbox"/> 10P | <input type="checkbox"/> 12P |
| <input type="checkbox"/> 300P | <input type="checkbox"/> 30P | <input type="checkbox"/> 50P |
- Phase
- | | |
|---------------------------------------|------------------------------|
| <input checked="" type="checkbox"/> 0 | <input type="checkbox"/> 180 |
|---------------------------------------|------------------------------|

Test results

- Complied Not complied

Test Level (%UT)	Dip / Int. (%UT)	Duration / Period	Results (criterion)
0%	100%	0.5 Period	A
70%	30%	25 Period	A
0%	100%	250 Period	C

Comment :

- A : There was no change of operation status during above testing.(0.5, 25 Period)
- C : The EUT power is turen off whe applied, But it works nomally wwhen the EUT is restarted after application . (250 Period)

6.11 Harmonics

Environmental Conditions

Temperature	(22.3 °C)
Humidity	(49 % R.H.)
Test Area	EMC Test Room
Test date	2023.09.14

6.11.1 Measurement procedure

The equipment is supplied in series with shunt(s) Rm or current transformer(s) from a source having the same nominal voltage and frequency as the rated supply voltage and frequency of the equipment.

Measurements shall be made under normal load, or conditions for adequate heat discharge, and under normal operating conditions.

User's operation controls or automatic programmers shall be set to produce the maximum harmonic component, for each successive harmonic component in turn. For the purpose of harmonic current limitation, equipment is classified as follows :

Class A : Equipment not specified in one of the three other Classes shall be considered as Class A equipment.

- Balanced three-phase equipment;
- Household appliances excluding equipment identified as Class D;
- Tools excluding portable tools;
- Dimmers for incandescent lamps;
- Audio equipment.

Class B : Portable tools; Arc welding equipment which is not professional equipment.

Class C : Lighting equipment.

Class D : Equipment having a specified power according to 6.2.2 less than or equal to 600 w, of the following types:

- Personal computers and personal computer monitors;
- Television receivers.
- refrigerators and freezers having one or more variable-speed drives to control compressor motor(s).

6.11.2 Used equipments

Equipment	Model no.	Manufacturer.	Serial no.	Next Cal. date	Used
PROGRAMMABLE AC POWER SOURCE	N4A06	Newtons4th Ltd.	91J-13186	2023.12.21	<input checked="" type="checkbox"/>
Precision Power Analyzer	PPA5511	Newtons4th Ltd	162-05556	2023.12.14	<input checked="" type="checkbox"/>
Impedance Network	IMP161	Newtons4th Ltd	91G-13185	2024.12.21	<input checked="" type="checkbox"/>



6.11.3 Test data

- Refer to attached test data

Test results

Complied Not complied

[HARMONICS]

14th September 2023 - 09:05:38		Ph:1 Page 1/3		IECSoft v2_7	
		IEC61000-3-2:2019+AMD1:2021			
Fluctuating Harmonics					
Instrument Details					
Instrument Model	PPA5511				
Serial Number	162-05556				
Firmware Version	2.185				
N4L Calibration Date	14th December 2023				
Instrument Version	Standard				
Source Details					
Source Model	N4A06				
Source Serial	91J-13186				
Source Frequency	50.000Hz				
Source Voltage RMS	230.000V				
Source Settling Time	10.0 s				
Test Settings					
Class	Class A				
Mode	Measured				
Equipment Under Test					
Brand	N/A				
Model	N/A				
Serial	N/A				
Impedance Network ID	N/A				
Test Conditions					
	User Entered		Measured		
Rated Voltage	N/A		227.663V		
Rated Current	N/A		6.899mA		
Rated Frequency	N/A		50.000Hz		
Rated Power	N/A		17.814mW		
Additional Test Information					
Measured Power Factor	0.0267				
Max Current THD	4.248k%				
Average THC	29.522mA				
Max Power	207.470mW				
Max F.Current	2.293mA				
Average F.Current	1.370mA				
Minimum Current	100A				
Additional Test Details					
Operator	N/A				
Lab Name	N/A				
Location	N/A				
Notes					
Signature					
Results	Test - N/A. Invalid DUT				

6.12 Flicker

Environmental Conditions

Temperature	(22.3 °C)
Humidity	(49 % R.H.)
Test Area	EMC Test Room
Test date	2023.09.14

6.12.1 Measurement procedure

EUT was connected to the power analyzer system.
 Measurement was performed to obtain the desired flicker parameters.
 The measuring time depends on which parameters are to be measured.

$$P_{lt} = 2 \text{ h}$$

$$P_{st} = 10 \text{ min}$$

Controls and automatic programs shall be set to produce the most unfavorable sequence of voltage changes, using only those combinations of controls and programs are mentioned by the manufacturer in the instruction manual.

6.12.2 Used equipments

Equipment	Model no.	Manufacturer.	Serial no.	Next Cal. date	Used
PROGRAMMABLE AC POWER SOURCE	N4A06	Newtons4th Ltd.	91J-13186	2023.12.21	<input checked="" type="checkbox"/>
Precision Power Analyzer	PPA5511	Newtons4th Ltd	162-05556	2023.12.14	<input checked="" type="checkbox"/>
Impedance Network	IMP161	Newtons4th Ltd	91G-13185	2024.12.21	<input checked="" type="checkbox"/>



6.12.3 Test data

- Refer to attached test data

Test results

Complied Not complied

[Flicker]

14th September 2023 - 11:25:43		Ph:1 Page 1/3		IECSoft v2_7	
		IEC61000-3-3:2013+AMD1:2019			
Flickermeter					
Instrument Details					
Instrument Model	PPA5511				
Serial Number	162-05556				
Firmware Version	2.185				
N4L Calibration Date	14th December 2023				
Instrument Version	Standard				
Source Details					
Source Model	N4A06				
Source Serial	91J-13186				
Source Frequency	50.000Hz				
Source Voltage RMS	230.000V				
Test Settings					
Class	Voltage				
Mode	Normal (4.0%)				
Minimum Current	10A				
PST	10 minutes				
PLT	12 PSTs				
Equipment Under Test					
Brand	N/A				
Model	N/A				
Serial	N/A				
Impedance Network ID	N/A				
Test Conditions					
	User Entered		Measured		
Rated Voltage	N/A		227.612V		
Rated Current	N/A		N/A		
Rated Frequency	N/A		50.000Hz		
Rated Power	N/A		N/A		
D max	0.0759% (Limit: 4.0%)				
T max	0.0000 s (Limit: 0.5 s)				
DC max	0.0099% (Limit: 3.3%)				
Additional Test Details					
Operator	N/A				
Lab Name	N/A				
Location	N/A				
Notes					
Signature					
Results	Phase1: INVALID - PASS				

7. Test Photographs

Radiated Emission (Below 1GHz)

[front]



[rear]

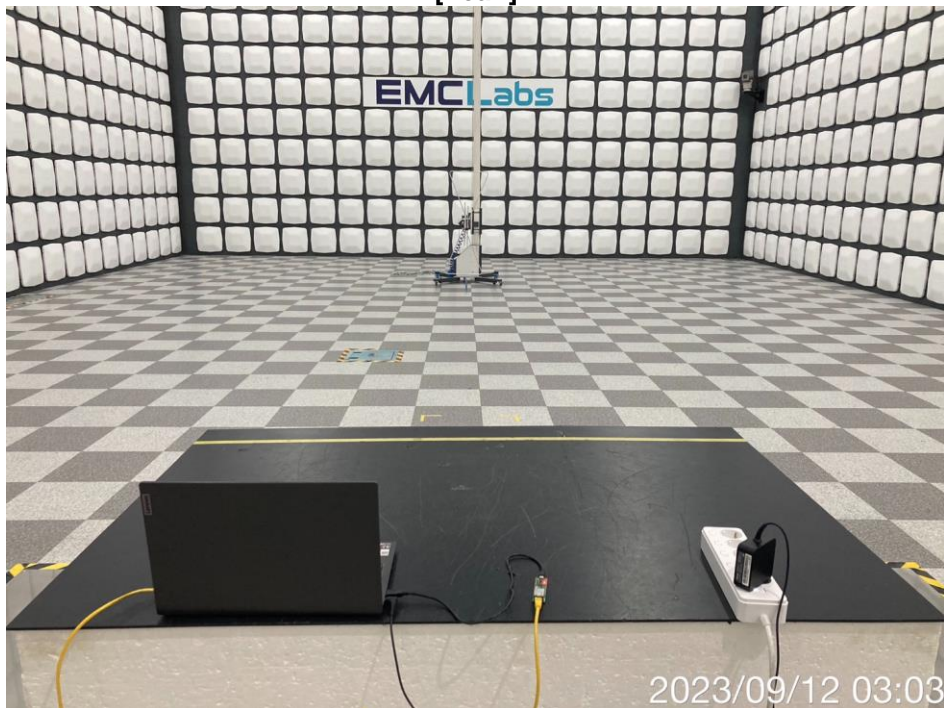

Radiated Emission (Above 1GHz)

[front]



[rear]

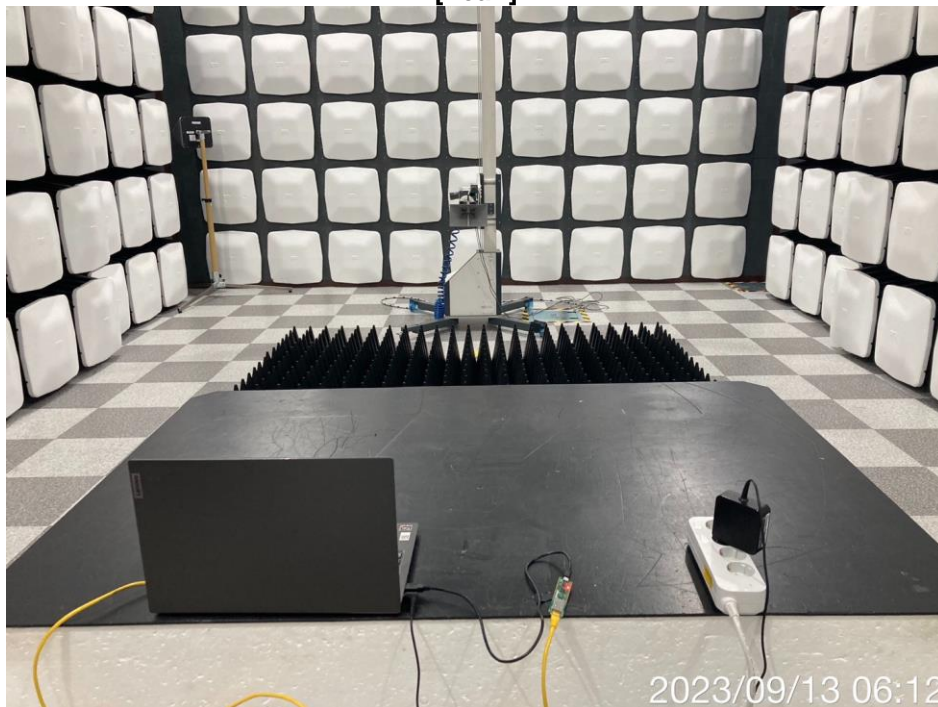

Conducted Emission (Main Power)

[front]



[rear]



Conducted Emission (Telecommunications Power)

[Front]



[Rear]



Electrostatic Discharge



Radio frequency electromagnetic field

[80 MHz to 1 GHz, Spot Frequency]



Electric Fast Transient, Surge, DIP/INT

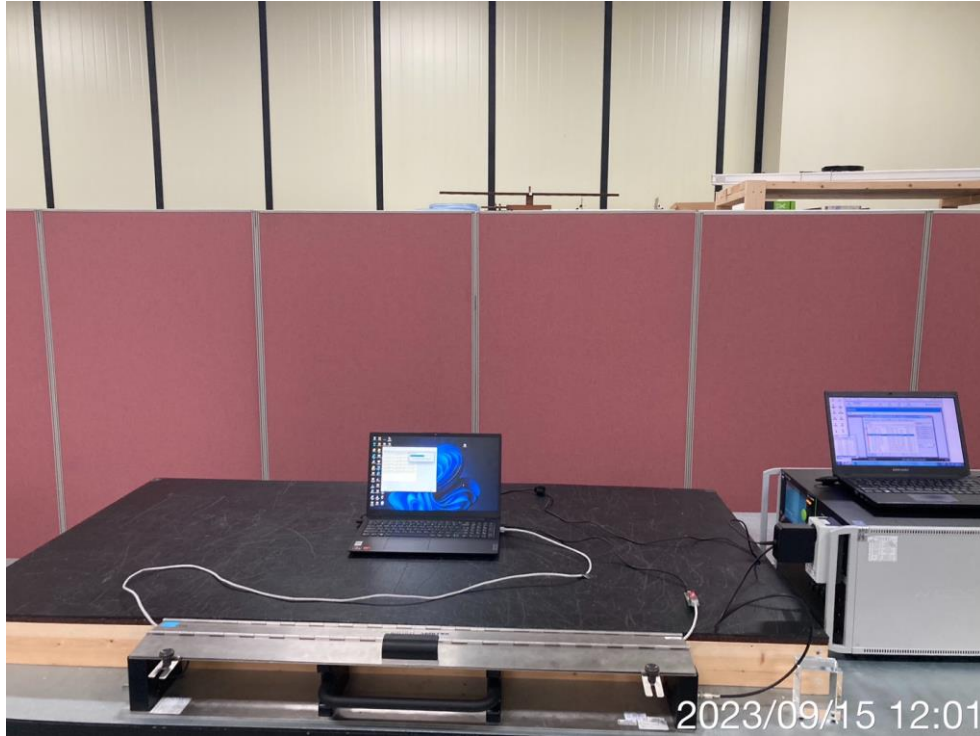

Conducted Immunity

[POWER PORT]



[DATA PORT]

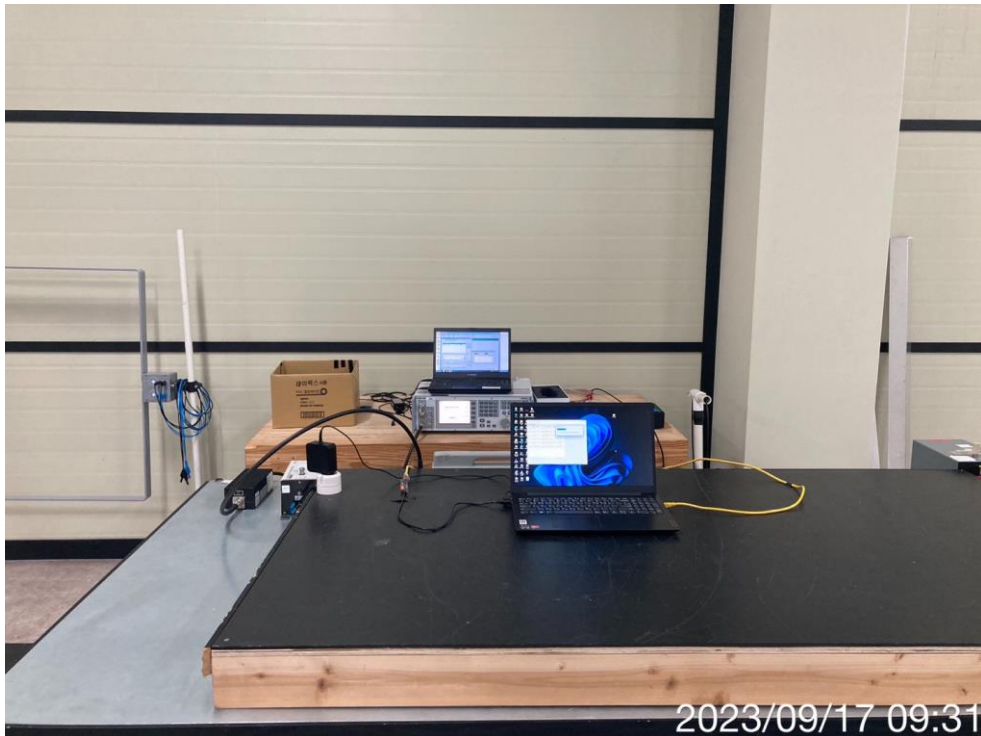

Magnetic field Immunity

N/A

Harmonics & Flicker



8. E.U.T. Photographs

[Front View]



[Rear View]

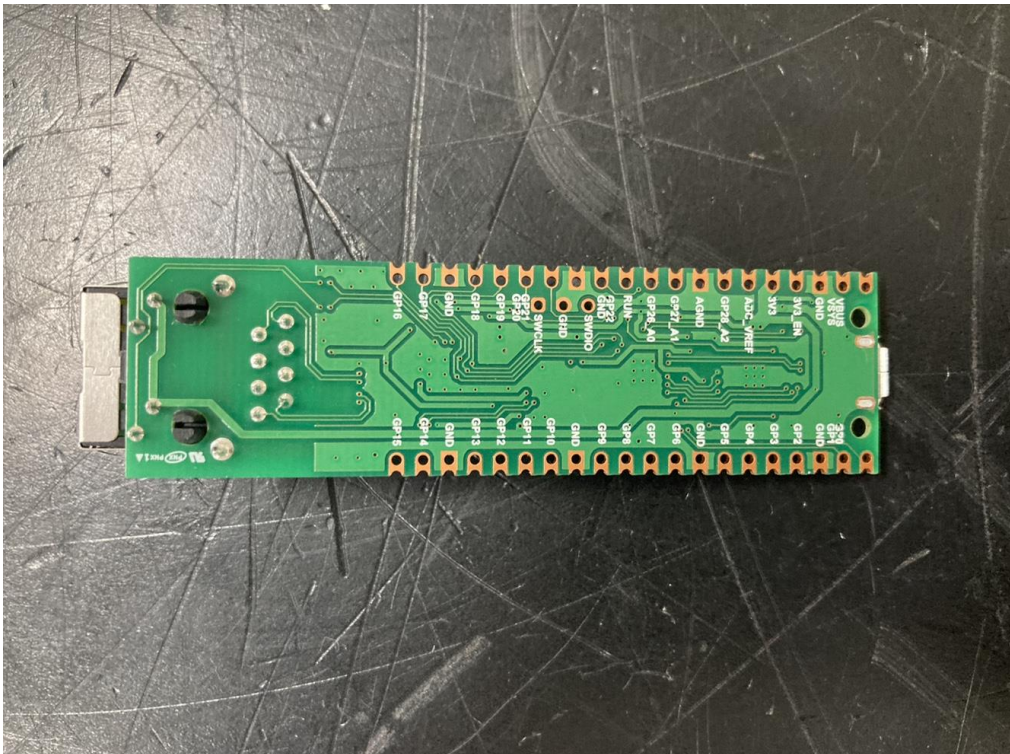

[Port#1_View]

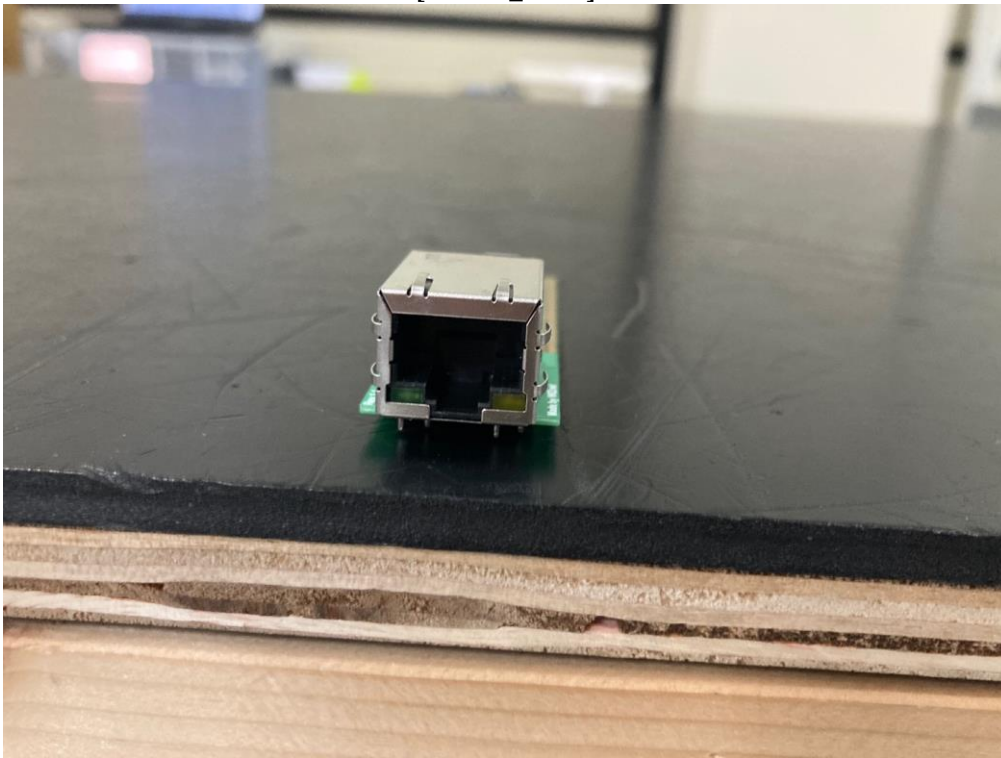

[Port#2_View]

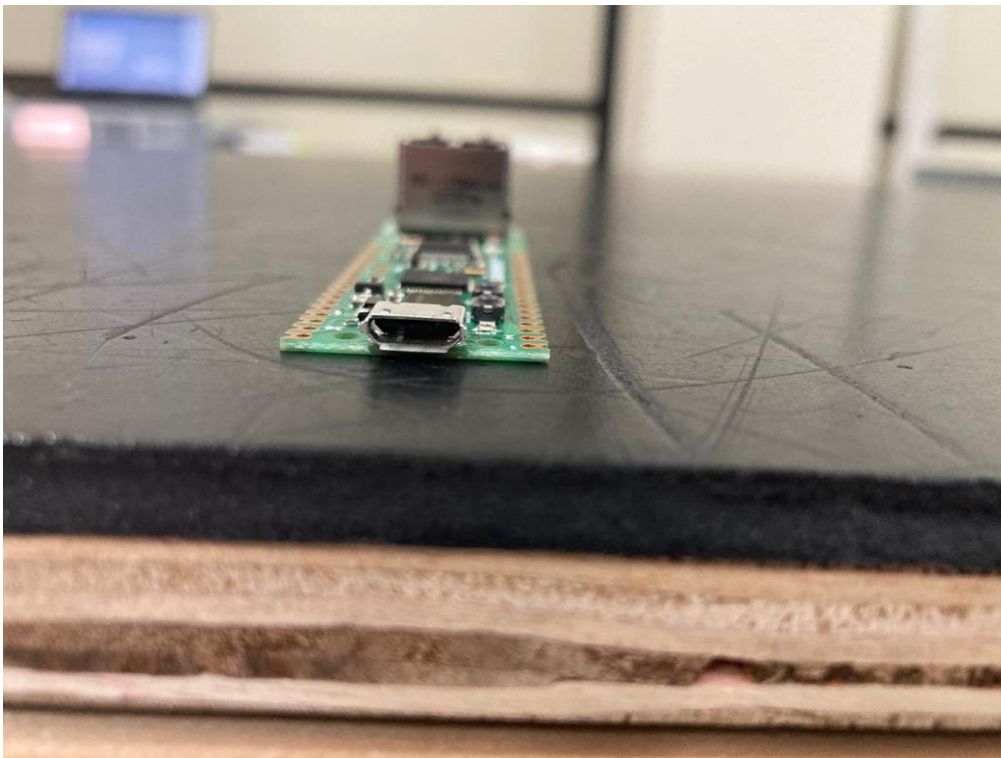

-THE END-